

# MHI

Manual No. '05·SRK-T·045

**TECHNICAL MANUAL**

**Collection data**

## **WALL MOUNTED TYPE ROOM AIR-CONDITIONER**

**(Split system, air to air heat pump type)**

**SRK20HD**

 **MITSUBISHI HEAVY INDUSTRIES LTD**



Большая библиотека технической документации  
<http://splitoff.ru/tehn-doc.html>  
каталоги, инструкции, сервисные мануалы, схемы.

# CONTENTS

<b>1. GENERAL INFORMATION</b> .....	<b>1</b>
1.1 Specific features .....	1
1.2 How to read the model name .....	1
<b>2. SELECTION DATA</b> .....	<b>2</b>
2.1 Specifications .....	2
2.2 Range of usage & limitations .....	3
2.3 Exterior dimensions .....	3
2.4 Piping system .....	4
2.5 Selection chart .....	5
<b>3. ELECTRICAL DATA</b> .....	<b>6</b>
3.1 Electrical wiring .....	6
<b>4. OUTLINE OF OPERATION CONTROL BY MICROCOMPUTER</b> .....	<b>7</b>
4.1 Operation control function by remote control switch .....	7
4.2 Unit ON/OFF button .....	8
4.3 Power blackout auto restart function .....	8
4.4 Flap control .....	9
4.5 Comfortable timer setting .....	9
4.6 Outline of heating operation .....	10
4.7 Outline of cooling operation .....	13
4.8 Outline of dehumidifying operation .....	14
4.9 Automatic operation .....	15
4.10 Protective control function .....	15
<b>5. APPLICATION DATA</b> .....	<b>17</b>
5.1 Selection of location for installation .....	18
5.2 Installation of indoor unit.....	19
5.3 Installation of outdoor unit .....	21
5.4 Refrigerant piping .....	21
5.5 Test run .....	23
5.6 Precautions for wireless remote controller installation and operation .....	23
<b>6. MAINTENANCE DATA</b> .....	<b>24</b>
6.1 Trouble shooting .....	24
6.2 Servicing .....	29

# 1 GENERAL INFORMATION

## 1.1 Specific features

The “Mitsubishi Daiya” room air-conditioner: SRK series are of split and wall mounted type and the unit consists of indoor unit and outdoor unit with refrigerant precharged in factory. The indoor unit is composed of room air cooling or heating equipment with operation control switch and the outdoor unit is composed of condensing unit with compressor.

### (1) Remote control flap

The flap can be automatically controlled by operating wireless remote controller.

- Air scroll: Flap operation is automatically control.
- Swing: This will swing the flap up and down.
- Memory flap: Once the flap position is set, the unit memorizes the position and continues to operate at the same position from the next time.

### (2) Automatic Operation

When the remote control switch is set on “auto(Δ)”, it will either automatically decide operation mode such as cooling, heating and thermal dry, or operate in the operation mode before it has been turned to automatic control.

### (3) Self diagnosis function

- We are constantly trying to do better service to our customers by installing such judges that show abnormality of operation as follows.

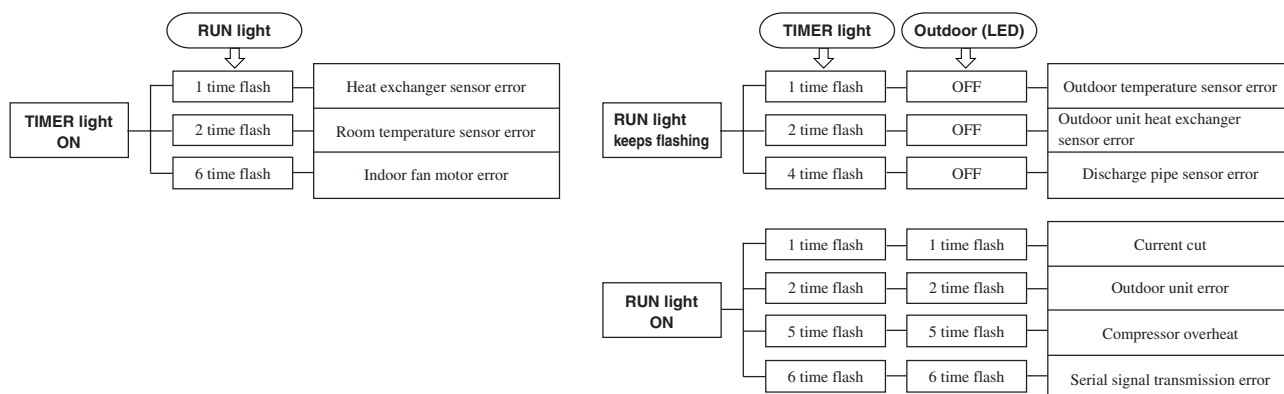

## 1.2 How to read the model name

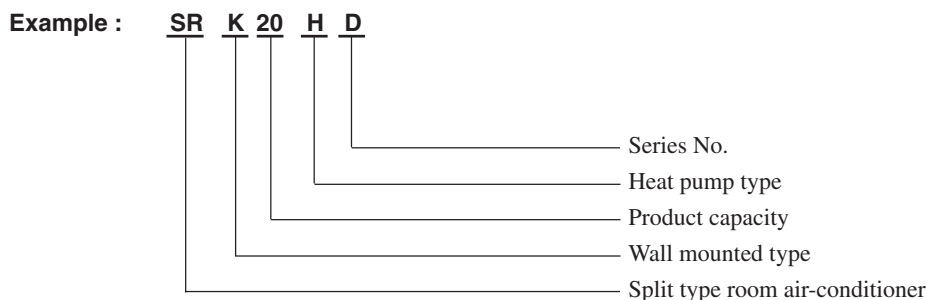

## 2 SELECTION DATA

### 2.1 Specifications

Model SRK20HD (Indoor unit)  
SRC20HD (Outdoor unit)

(220/230/240V)

Item		Model	SRK20HD	SRC20HD
Cooling capacity <sup>(1)</sup>		W	2000	
Heating capacity <sup>(1)</sup>		W	2200	
Power source			1 Phase, 220-240V, 50Hz	
Operation data <sup>(1)</sup>	Cooling input	kW	0.635	
	Running current (Cooling)	A	3.1/3.0/2.9	
	Heating input	kW	0.605	
	Running current (Heating)	A	3.0/2.9/2.8	
	Inrush current	A	18	
	COP		Cooling: 3.15 Heating: 3.64	
Noise level	Cooling	sound level	Hi: 35, Me: 28, Lo: 26	45
		Power level	53	59
	Heating	sound level	Hi: 35, Me: 31, Lo: 27	45
		Power level	53	59
Exterior dimensions		mm	250 × 815 × 249	540 × 720 × 290
Height × Width × Depth				
Color			Cool white	Stucco white
Net weight		kg	9.0	32
Refrigerant equipment				RM5485GNE95 (Rotary type) × 1
Compressor type & Q'ty			-	
Motor		kW	-	0.75
Starting method			-	Line starting
Heat exchanger			Louver fins & inner grooved tubing	Straight fin & inner grooved tubing
Refrigerant control			Capillary tubes	
Refrigerant <sup>(3)</sup>		kg	R22 0.77 (Pre-Charged up to the piping length of 7.5m)	
Refrigerant oil		ℓ	0.35 (BARREL FREEZE 32SAM)	
Deice control			MC control	
Air handling equipment				
Fan type & Q'ty			Tangential fan × 1	Propeller fan × 1
Motor		W	14	12
Air flow (at High)	(Cooling)	CMM	7.5	26
	(Heating)		7.5	26
Air filter, Q'ty			Polypropylene net (washable) × 2	-
Shock & vibration absorber			-	Cushion rubber (for compressor)
Electric heater			-	-
Operation control				
Operation switch			Wireless-Remote controller	-
Room temperature control			MC. Thermostat	-
Pilot lamp			RUN (Green), TIMER (Yellow), HI POWER (Green), ECONO (Orange)	
Safety equipment			Frost protection, Serial signal error protection Fan motor error protection	Compressor overheat protection, Overcurrent protection, Serial signal error protection
Refrigerant piping	O.D	mm (in)	Liquid line: φ6.35 (1/4") Gas line: φ9.52 (3/8")	
	Connecting method		Flare connecting	
	Attached length of piping		Liquid line: 0.4 m Gas line : 0.33 m	-
	Insulation		Necessary (Both sides)	
Drain hose			Connectable	
Power source cord			2.5 m (3 cores with Earth)	
Connection wiring	Size × Core number		1.5 mm <sup>2</sup> × 4 cores (Including earth cable)	
	Connecting method		Terminal block (Screw fixing type)	
Accessories (included)			Mounting kit	
Optional parts			-	

Notes (1) The data are measured at the following conditions.

Operation	Item	Indoor air temperature		Outdoor air temperature		Standards
		DB	WB	DB	WB	
Cooling		27°C	19°C	35°C	24°C	ISO-T1, JIS C9612
Heating		20°C	-	7°C	6°C	ISO-T1, JIS C9612

The piping length is 7.5m.

(2) The operation data are applied to the 220/230/240V districts respectively.

(3) The refrigerant quantity to be charged includes the refrigerant in 7.5 m connecting piping.

If the piping length is longer, when it is less than 10 m, add 20 g refrigerant per meter and when it is 10 to 15 m, add 30 g refrigerant per meter.

## 2.2 Range of usage & limitations

Item	Model	SRK20HD
Indoor return air temperature (Upper, lower limits)		Refer to the selection chart
Outdoor air temperature (Upper, lower limits)		
Refrigerant line (one way) length		Max. 15m
Vertical height difference between outdoor unit and indoor unit		Max. 5m (Outdoor unit is higher) Max. 5m (Outdoor unit is lower)
Power source voltage		Rating $\pm$ 10%
Voltage at starting		Min. 85% of rating
Frequency of ON-OFF cycle		Max. 10 times/h
ON and OFF interval		Max. 3 minutes

## 2.3 Exterior dimensions

### (1) Indoor unit

Model SRK20HD

Unit: mm

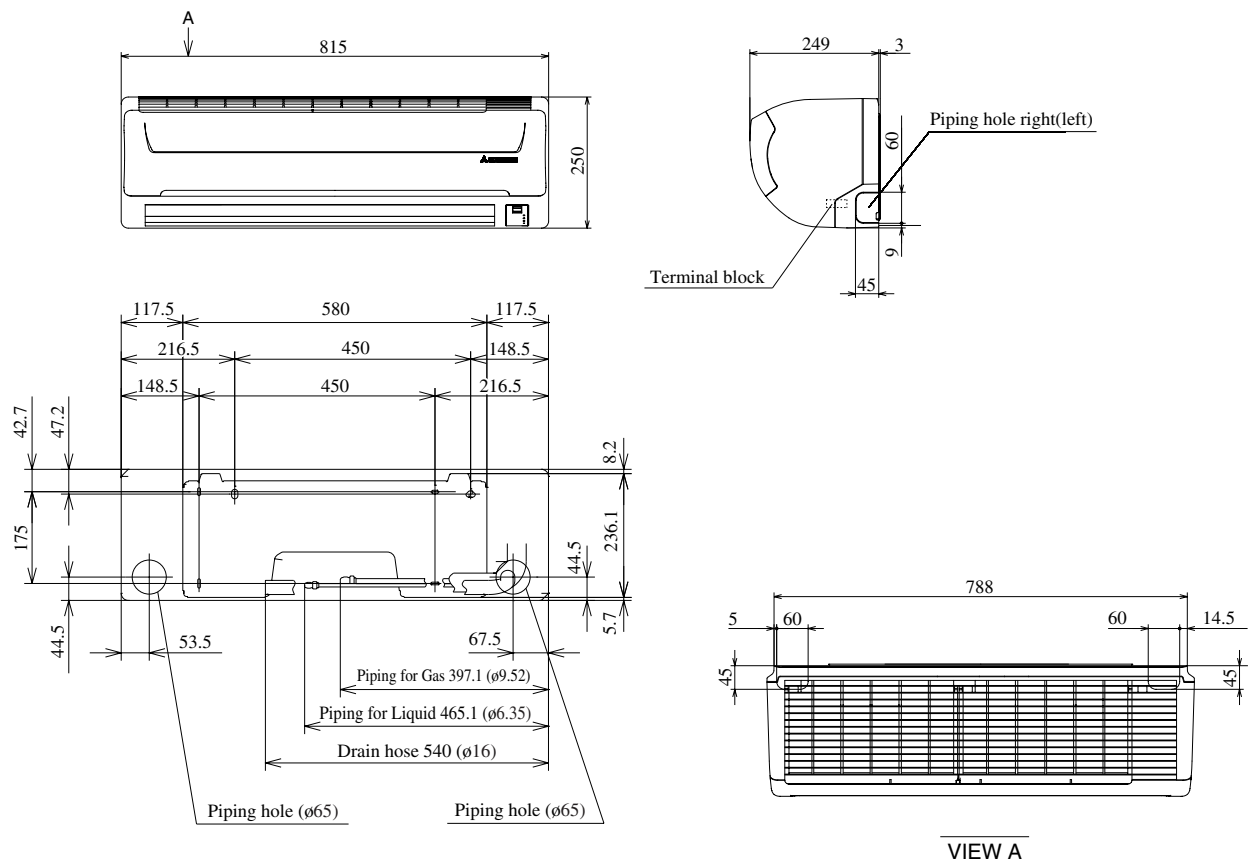

**(2) Outdoor unit**

**Model SRC20HD**

Unit: mm

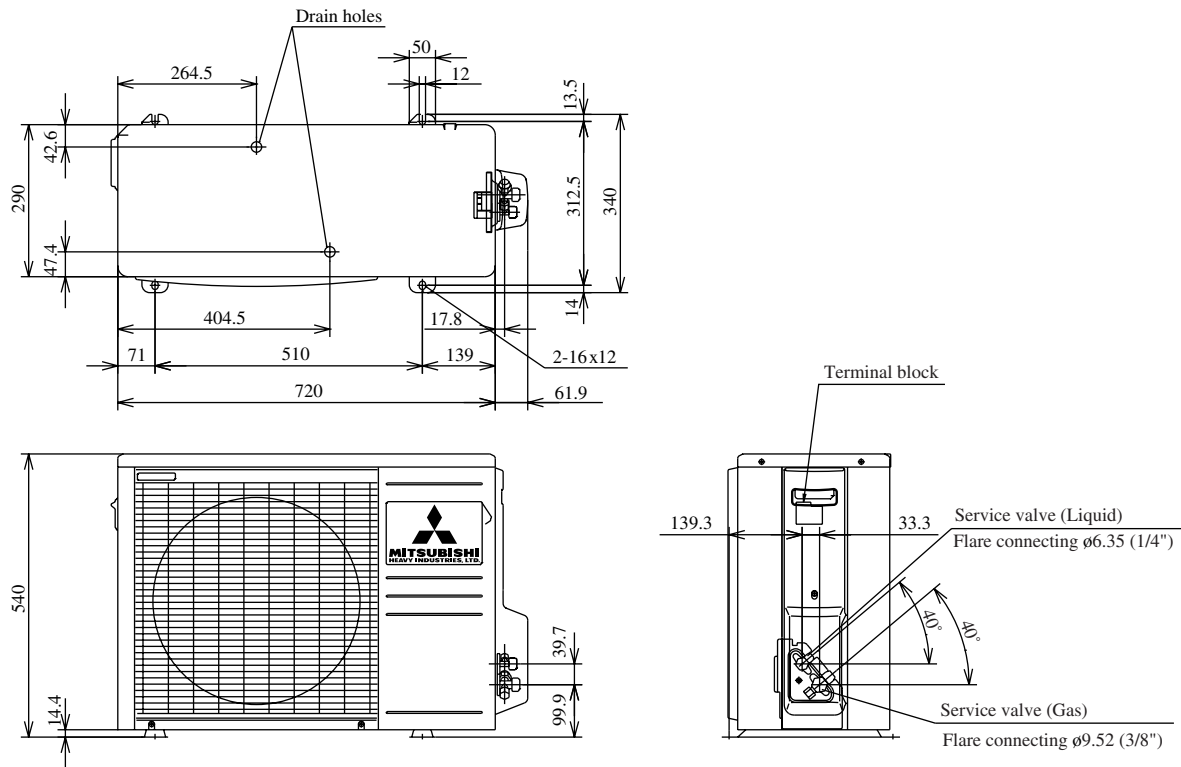

**2.4 Piping system**

**Model SRK20HD**

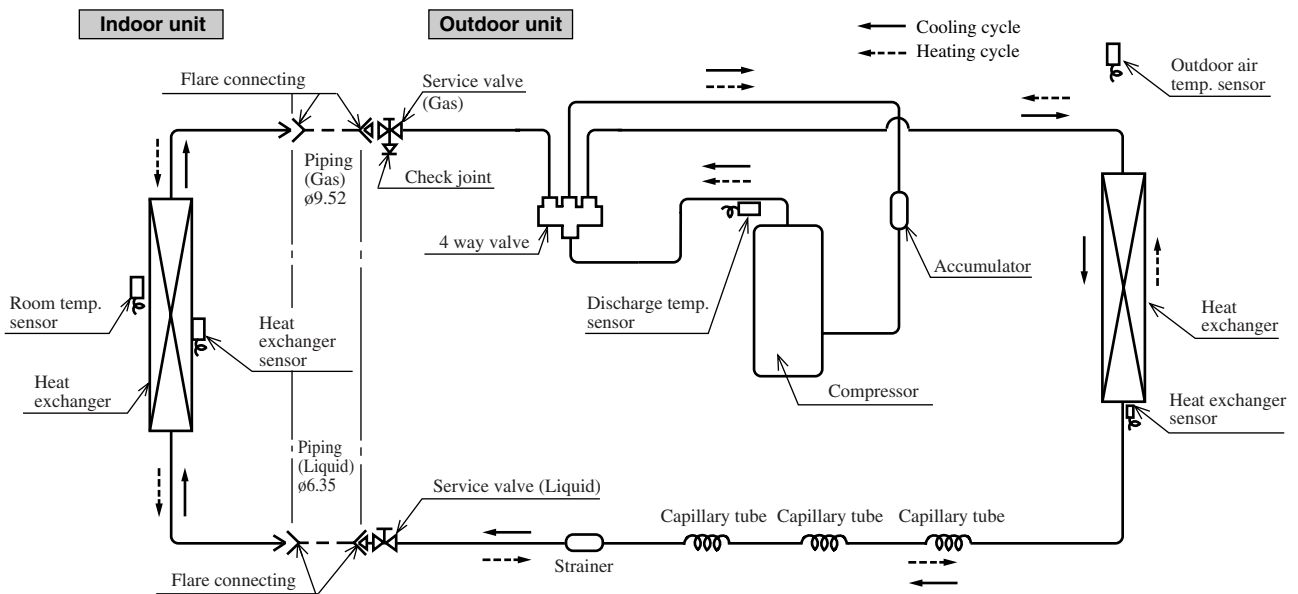

## 2.5 Selection chart

Correct the cooling and heating capacity in accordance with the conditions as follows. The net cooling and heating capacity can be obtained in the following way.

**Net capacity = Capacity shown on specification × Correction factors as follows.**

### (1) Coefficient of cooling and heating capacity in relation to temperatures

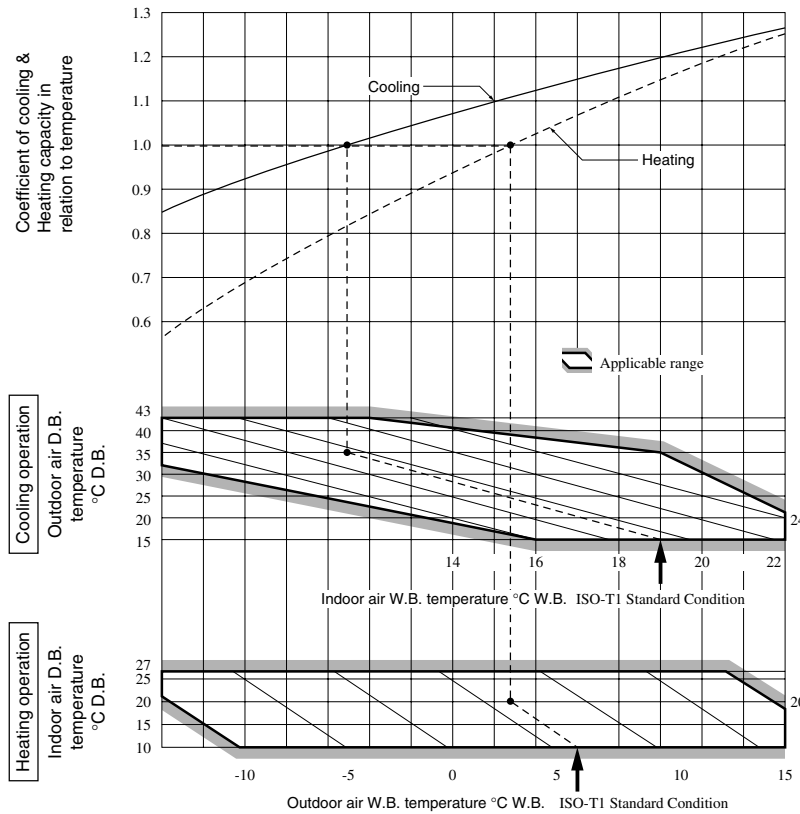

### (2) Correction of cooling and heating capacity in relation to one way length of refrigerant piping

It is necessary to correct the cooling and heating capacity in relation to the one way piping length between the indoor and outdoor units.

Piping length [m]	7	10	15
Cooling	1.0	0.99	0.975
Heating	1.0	1.0	1.0

### (3) Correction relative to frosting on outdoor heat exchanger during heating

In additions to the foregoing corrections (1), (2) the heating capacity needs to be adjusted also with respect to the frosting on the outdoor heat exchanger.

Air inlet temperature of outdoor unit in °CWB	-10	-9	-7	-5	-3	-1	1	3	5
Adjustment coefficient	0.95	0.94	0.93	0.91	0.88	0.86	0.87	0.92	1.00

### How to obtain the cooling and heating capacity

Example : The net cooling capacity of the model SRK20HD with the piping length of 15m, indoor wet-bulb temperature at 19.0°C and outdoor dry-bulb temperature 35°C is Net cooling capacity =

$$\begin{array}{ccccccc}
 \frac{2000}{\uparrow} & \times & \frac{0.975}{\uparrow} & \times & \frac{1.0}{\uparrow} & = & 1950 \text{ w} \\
 \text{SRK20HD} & & \text{Length 15m} & & \text{Factor by air} & & \\
 & & & & \text{temperatures} & & 
 \end{array}$$

# 3 ELECTRICAL DATA

## 3.1 Electrical wiring

Model SRK20HD

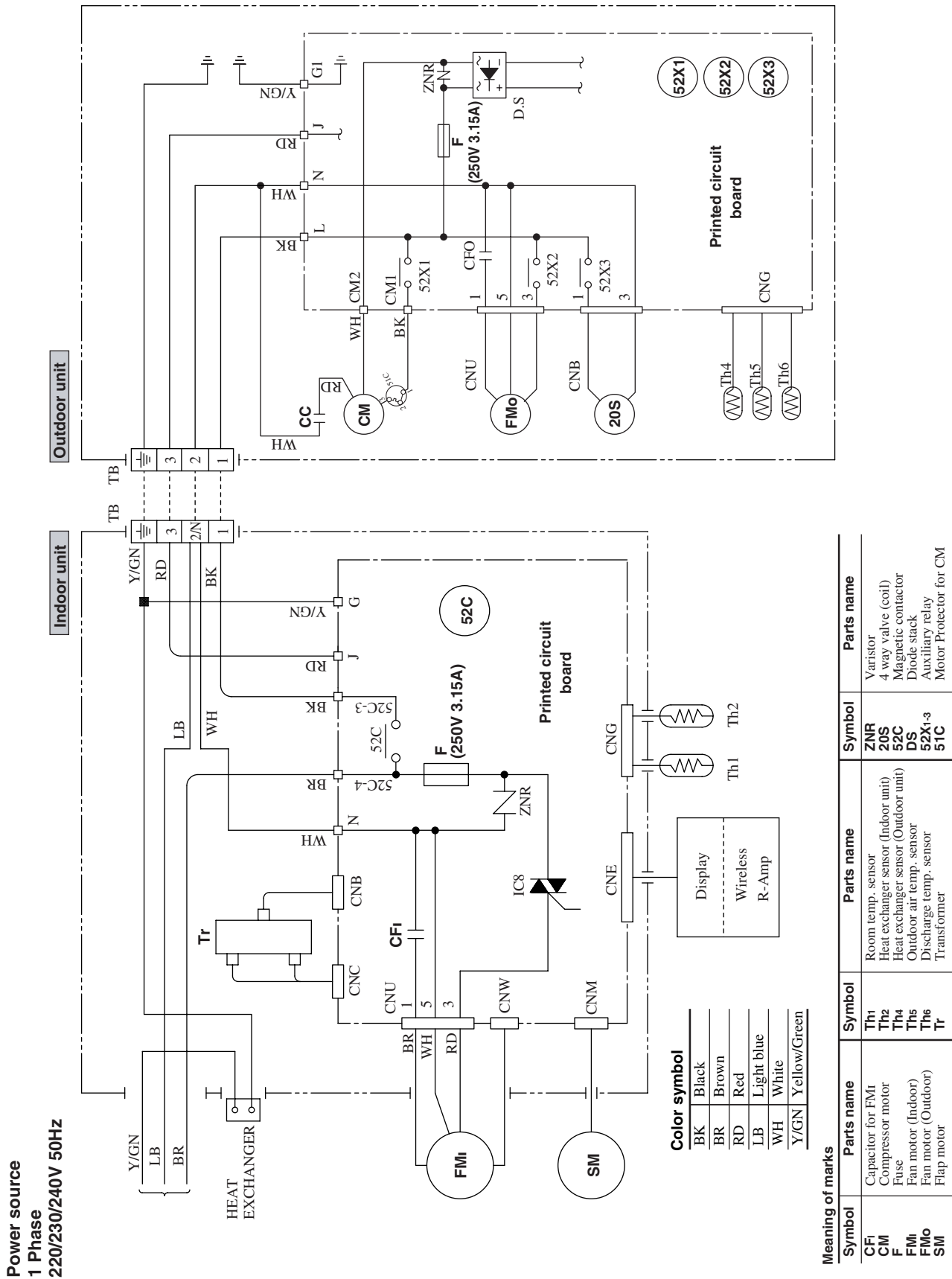



# 4 OUTLINE OF OPERATION CONTROL BY MICROCOMPUTER

## 4.1 Operation control function by remote control switch

### Remote controller

Model SRK20HD

#### ◆ Operation section

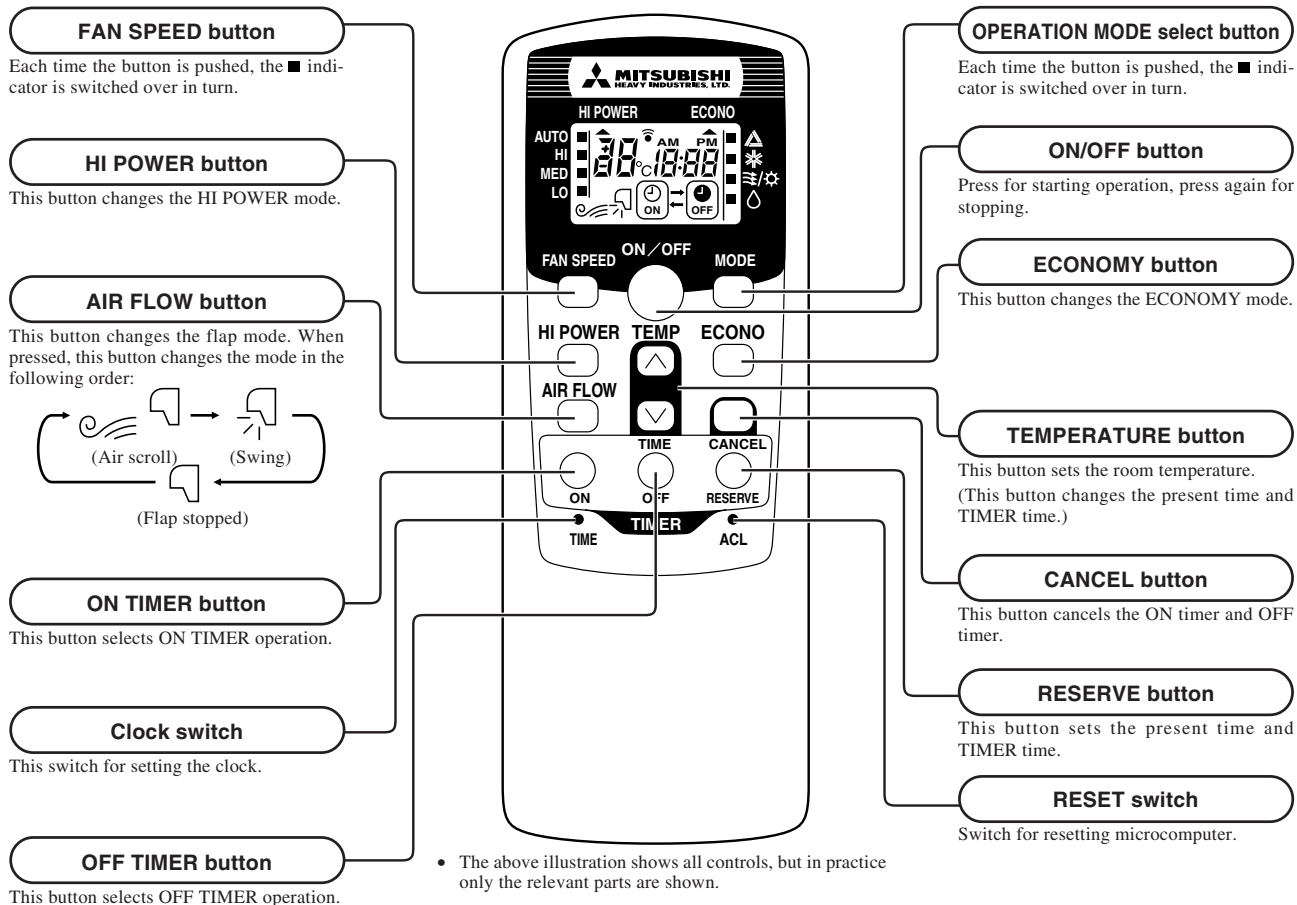

#### ◆ Indication section

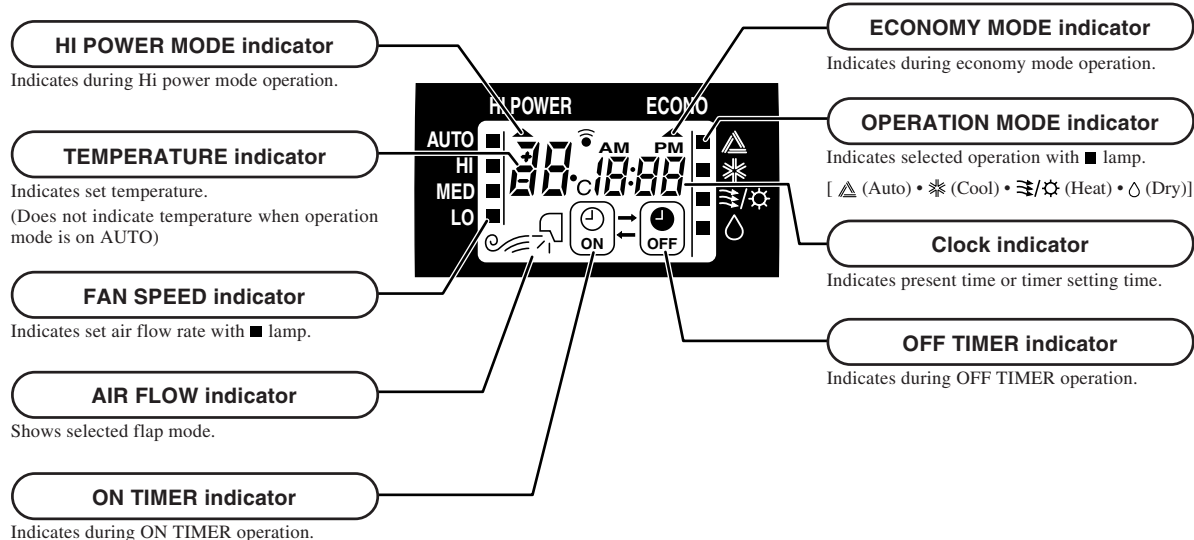

## Unit indication section

Model SRK20HD

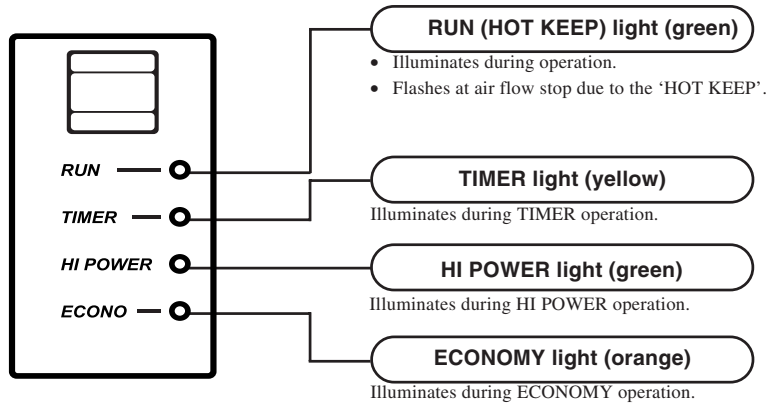

## 4.2 Unit ON/OFF button

When the remote controller batteries become weak, or if the remote controller is lost or malfunctioning, this button may be used to turn the unit on and off.

### (a) Operation

Push the button once to place the unit in the automatic mode. Push it once more to turn the unit off.

### (b) Details of operation

The unit will go into the automatic mode in which it automatically determines, from room temperature (as detected by sensor), whether to go into the cooling, thermal dry or heating modes.

Function	Room temperature setting	Fan speed	Flap	Timer switch
Operation mode				
Cooling	About 25°C	Auto	Auto	Continuous
Thermal dry	About 25°C			
Heating	About 26°C			

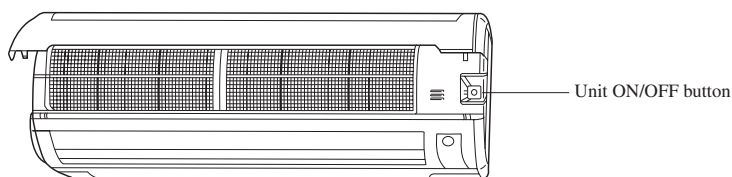

## 4.3 Power blackout auto restart function

(1) Power blackout auto restart function is a function that records the operational status of the air-conditioner immediately prior to it being switched off by a power cut, and then automatically resumes operations at that point after the power has been restored.

(2) The following settings will be cancelled:

(a) Timer settings

(b) High-power operations

- Notes
- (1) The power blackout auto restart function is set on when the air-conditioner is shipped from the factory. Consult with your dealer if this function needs to be switched off.
  - (2) When power failure occurs, the timer setting is cancelled. Once power is resumed, reset the timer.
  - (3) If the jumper wire (J7) "REMOTE/AUTORESTART" is cut, auto restart is disabled. (See the diagram at right)

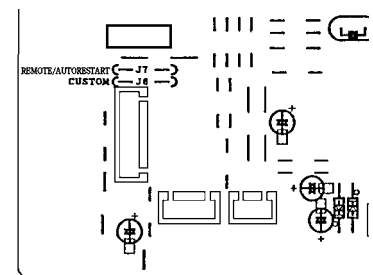

## 4.4 Flap control

Control the flap by AIRFLOW button on the wireless remote controller.

### (1) Air scroll

The flap will be automatically set to the angle of air flow best to operation.

#### (a) Starting time of operation

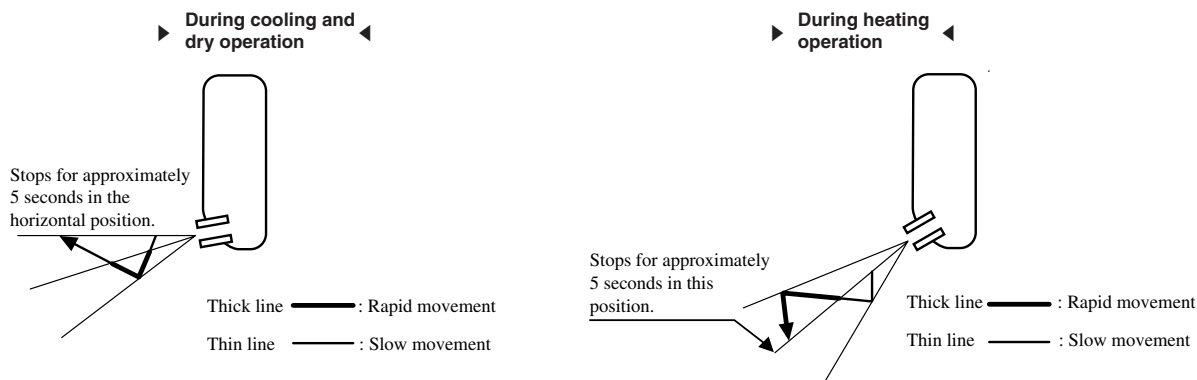

#### (b) When not operating

The flap returns to the position of air flow directly below, when operation has stopped.

### (2) Memory flap

While the flap is operating if the AIRFLOW button is pushed once, it stops swinging at an angle.

As this angle is memorized in the microcomputer, the flap will be automatically set to the angle when next operation is started.

- Recommendable stopping angle of the flap

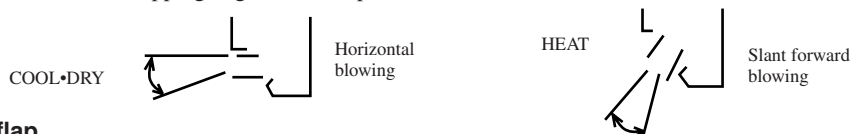

### (3) Swing flap

Flap moves in upward and downward directions continuously.

## 4.5 Comfortable timer setting

If the timer is set at ON when the operation select switch is set at the cooling or heating, or the cooling or heating in auto mode operation is selected, the comfortable timer starts and determines the starting time of next operation based on the initial value of 15 minutes and the relationship between the room temperature at the setting time (temperature of room temperature sensor) and the setting temperature. (Max. 60 minutes)

Operation mode	Operation start time correction value (Min.)		
At cooling	$3 < \text{Room temp.} - \text{Setting temp.}$	$1 < \text{Room temp.} - \text{Setting temp.} \leq 3$	$\text{Room temp.} - \text{Setting temp.} \leq 1$
	+5	No change	-5
At heating	$3 < \text{Setting temp.} - \text{Room temp.}$	$2 < \text{Setting temp.} - \text{Room temp.} \leq 3$	$\text{Setting temp.} - \text{Room temp.} \leq 2$
	+5	No change	-5

Notes (1) At 5 minutes before the timer ON time, operation starts regardless of the temperature of the room temperature sensor (Th1).

(2) This function does not actuate when the operation select switch is set at the dehumidifying as well as the dehumidifying in the auto mode.

However, the operation of item (1) above is performed during the dehumidifying in the auto mode.

(3) During the comfortable timer operation, both the RUN light and TIMER light illuminate and the TIMER light goes off after expiration of the timer, ON setting time.

#### (Example) Heating

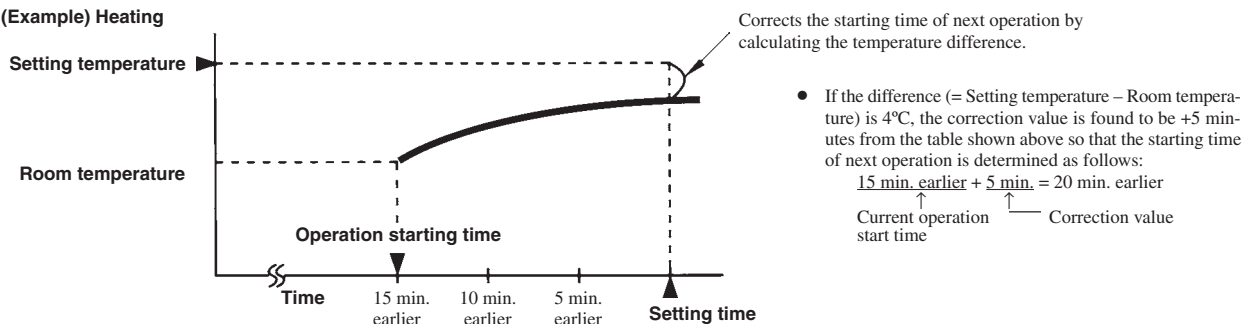

## 4.6 Outline of heating operation

### (1) Operation of major functional components

Functional components \ Item	When the compressor command is OFF	When the compressor command is ON	When the compressor goes OFF due to an abnormal stop.
Indoor fan motor	ON	ON	OFF
Flaps	ON or OFF	ON or OFF	Stop position control
Display	Lights up	Lights up	Lights up or flashes
52C	ON	ON	OFF after stop mode
Outdoor fan motor	OFF	ON	OFF
4-way valve	Depending on the stop mode	ON	Depending on the stop mode

### (2) Fan speed switching

Fan speed switching \ Flow control	AUTO	HIGH	MED	LOW
Air scroll	Auto fan control	Speed 6	Speed 4	Speed 2
Swing flap		Speed 6	Speed 4	Speed 2
Swing stop		Speed 6	Speed 4	Speed 2

#### (a) Auto fan control

The indoor fan is automatically controlled in accordance with the difference between the room temperature (detected by the room temperature sensor) and the thermostat setting as shown below.

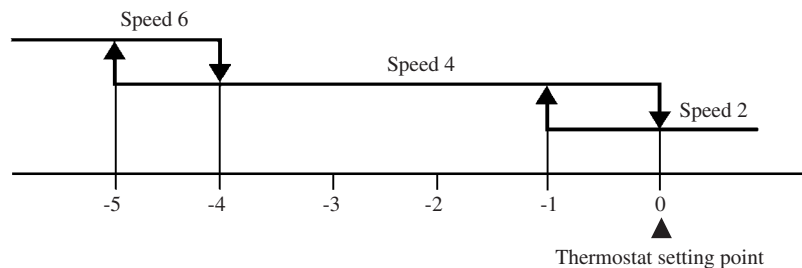

### (3) Thermostat operation

The compressor and outdoor fan are turned on and off as shown below according to the temperature setting.

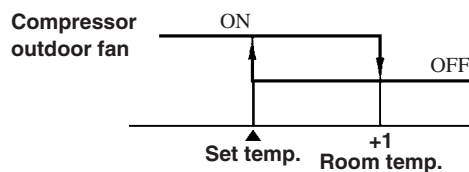

### (4) Hot keep

This function controls the indoor unit fan speed as shown below in accordance with the temperature sensed by the indoor heat exchanger sensor.

#### (a) When the compressor and outdoor unit fan are operating

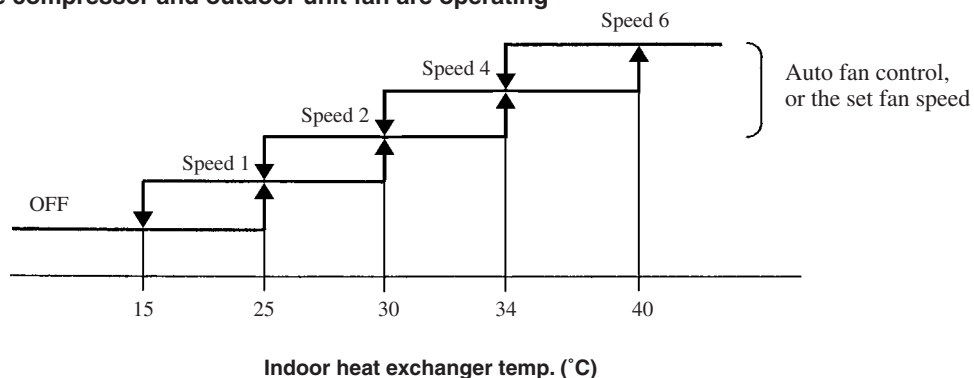

**(b) When the compressor and outdoor fan are stopped**

1) While the compressor operation is delayed.

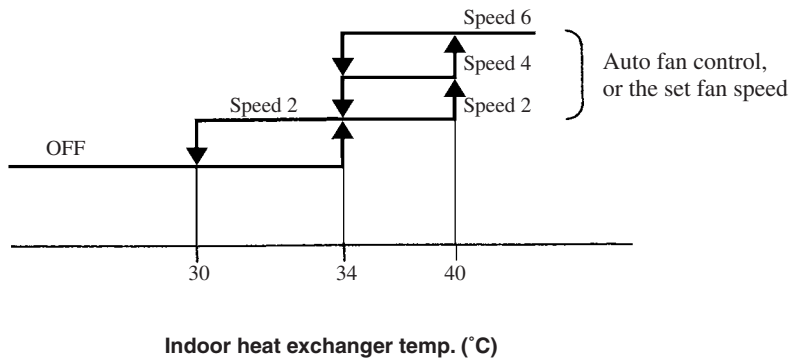

2) Up until 5 minutes have passed since the end of a compressor start delay operation, when 52C goes OFF, the indoor unit's fan speed changes forcibly from OFF to speed 1.

(c) To accomplish rapid recovery from the thermostat off state, after the compressor and outdoor unit's fan go OFF, the set temperature is raised by 1°C until 1 minute passes after the hot keep end temperature has been reached following restarting.

**(5) Hot spurt**

- (a) For 40 minutes after a heating operation begins, the system runs with set temperature raised by 2°C.
- (b) In the following cases, this function is canceled and does not activate afterwards.
  - 1) When the compressor and outdoor unit fan have been turned OFF by the thermostat going off.
  - 2) During high pressure control operation.

**(6) High power operation ("HI POWER" button on the remote controller : ON)**

The system runs under the following conditions for 15 minutes without relation to the set temperature or the fan speed setting.

Indoor unit fan	Speed 6 fixed
Outdoor unit fan	ON
Compressor	ON

Notes (1) Room temperature is not adjusted during the HI POWER operation.  
 (2) Protective function will actuate with priority even during the HI POWER operation.

**(7) Defrost operation**

- (a) Starting conditions (Defrost operation begins when all the following conditions are satisfied.)
  - ① 40 minutes have passed since the heating operation began. (Accumulated operation time)
  - ② 40 minutes have passed since the previous defrosting operation ended. (Accumulated operation time)
  - ③ The outdoor unit heat exchanger sensor temperature is -5°C or lower continuously for 3 minutes.
  - ④ The difference between the outdoor air temperature sensor temperature and the outdoor heat exchange sensor temperature is  $\geq 4.5^\circ\text{C}$ .
  - ⑤ The compressor is running.

Also, the number of times the compressor goes OFF is counted, and when it reaches 10 or more times, if the conditions in ①, ② and ③ above (except that the outdoor heat exchanger sensor temperature is -1°C), the defroster operation starts.
- (b) End conditions (when either of the following conditions is satisfied)
  - ① Outdoor heat exchanger sensor temperature: 9°C or higher
  - ② Defrosting operation has continued for 10 minutes.

**(c) Operation of functional components during defrosting operation**

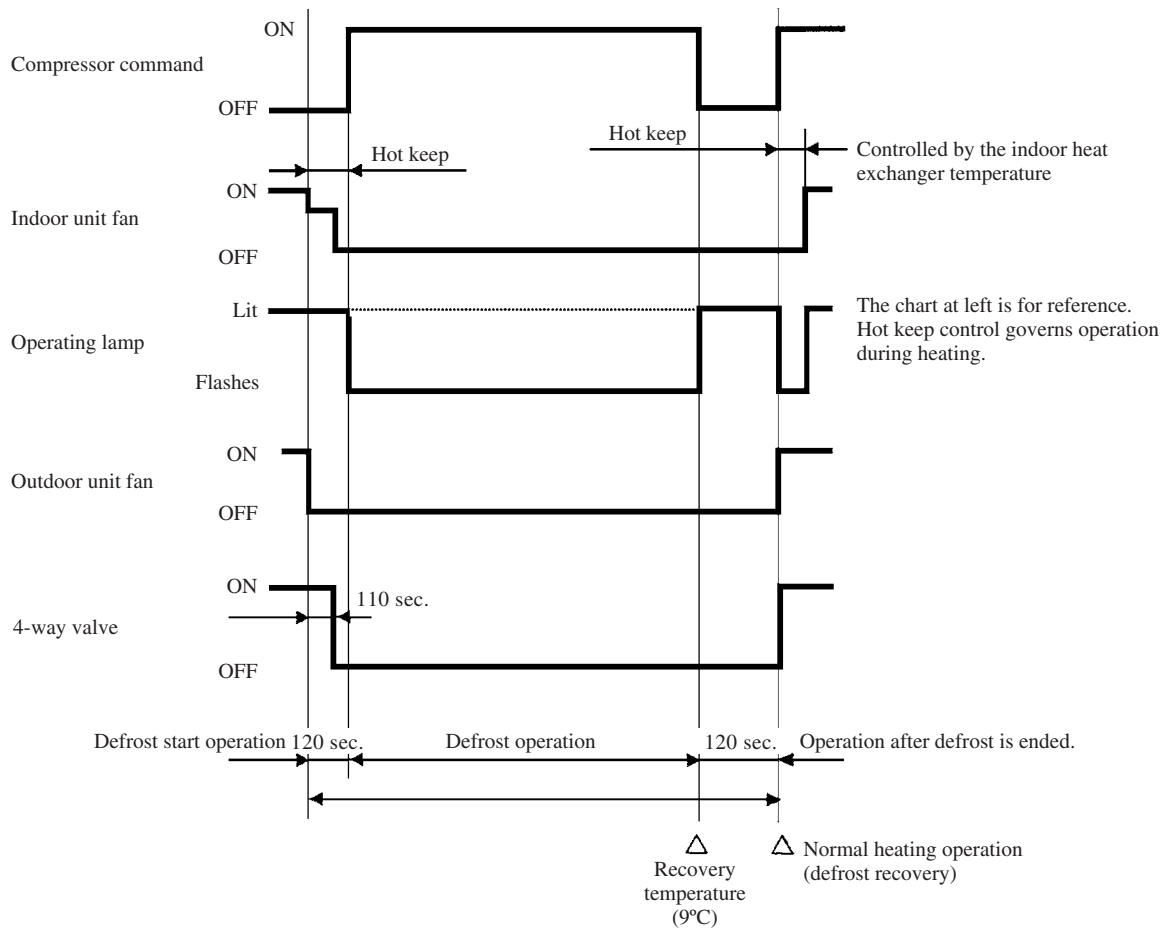

**(8) Forced defrost**

(a) During trial operation, if defrost operation is performed, defrost operation can be performed only once time, in accordance with the following operation.

1) Remote control operation

Operation	Run
Operation mode	Heating
Set temperature	19°C
Fan speed select	Low
Air flow setting	Swing
On timer	ON
Current time	On after 180 min.condition
On timer time	

2) Functional components operation

Compressor	ON
4-way valve	OFF
Indoor unit fan	OFF
Flap	Fully closed
Outdoor unit fan	OFF
Display	Same as defrost

(b) If remote control operation is performed, for 1 minute after 3-minute timer operation, the operation is canceled if one of the following conditions is satisfied.

- ① Outdoor heat exchanger sensor temperature: 14°C or higher
- ② 10 minutes has passed (including the 1 minute of forced operation).

**(9) ECONO operation (“ECONO” button on the remote controller : ON)**

The set temperature changes as shown at right and the indoor unit fan runs at speed 3.

Running time	Set temperature compensation
Running start ~ 1 hour	Set temperature -1.0
1~2 hours	Set temperature -2.0
2 hours ~	Set temperature -2.5

## 4.7 Outline of cooling operation

### (1) Operation of major functional components

Functional components \ Item	When the compressor command is OFF	When the compressor command is ON	When the compressor goes OFF due to an abnormal stop.
Indoor fan motor	ON	ON	OFF
Flaps	ON or OFF	ON or OFF	Stop position control
Display	Lights up	Lights up	Lights up or flashes
52C	ON	ON	OFF after stop mode
Outdoor fan motor	OFF	ON	OFF
4-way valve	Depending on the stop mode	OFF	Depending on the stop mode

### (2) Fan speed switching

Fan speed switching \ Flow control	AUTO	HIGH	MED	LOW
Air scroll	Auto fan control	Speed 5	Speed 3	Speed 2
Swing flap		Speed 5	Speed 3	Speed 2
Swing stop		Speed 5	Speed 3	Speed 2

#### (a) Auto fan control

The indoor fan is automatically controlled in accordance with the difference between the room temperature (detected by the room temperature sensor) and the thermostat setting as shown below.

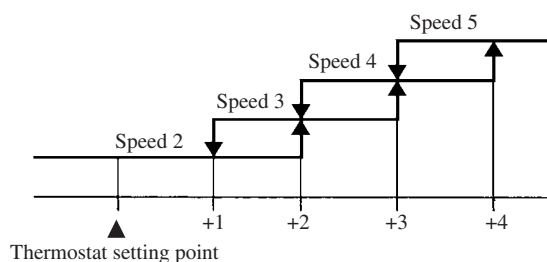

### (3) Thermostat operation

The compressor and outdoor fan are turned on and off as shown below according to the temperature setting.

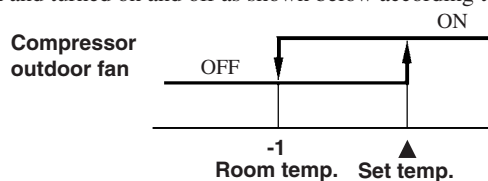

### (4) High Power operation ( "HI POWER" button on the remote controller : ON)

The following operation is performed for 15 minutes without relation to the set temperature or fan speed setting.

Indoor unit fan	Speed 6 fixed
Outdoor unit fan	ON
Compressor	ON

Notes (1) Room temperature is not adjusted during the HI POWER operation.  
 (2) Protective functions will actuate with priority even during the HI POWER operation.

### (5) ECONO operation ( "ECONO" button on the remote controller : ON)

The set temperature changes as shown at right, and the indoor unit fan speed is set on speed 2.

Running time	Set temperature compensation
Running start ~ 1 hour	Set temperature +0.5
1~2 hours	Set temperature +1.0
2 hours ~	Set temperature +1.5

## 4.8 Outline of dehumidifying operation

- (1) Choose the appropriate operation block area by the difference between room temperature and thermostat setting temperature as shown below.

• Operation block area

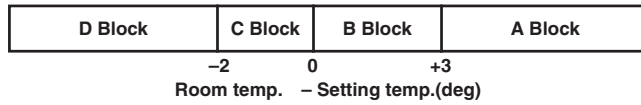

- (2) Start up operation

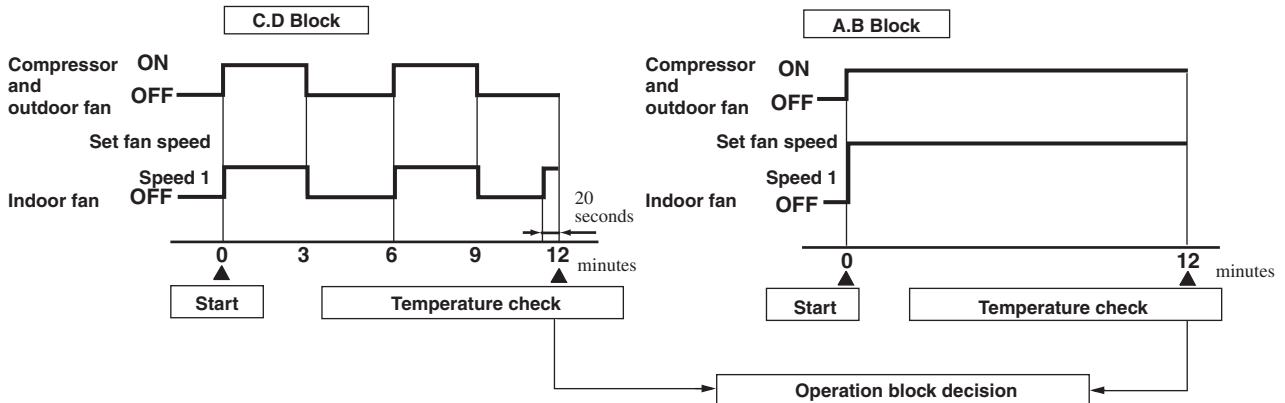

Note (1) Thermostat operation is performed in A, B Block. When compressor and indoor fan stop by thermostat operation within 12 minutes from start, temperature check is performed by operating indoor fan at speed 1 for 20 seconds before finishing 12 minutes and allowing decision of next operation block.

- (3) DRY operation

After finishing start up operation described in (2) above, thermal dry operation is performed at 8 minutes intervals, according to the difference between room temperature and thermostat setting temperature as shown below.

Beside, 1 cycle of this operating time consists of 8 minutes, 7 cycle operation is performed then.

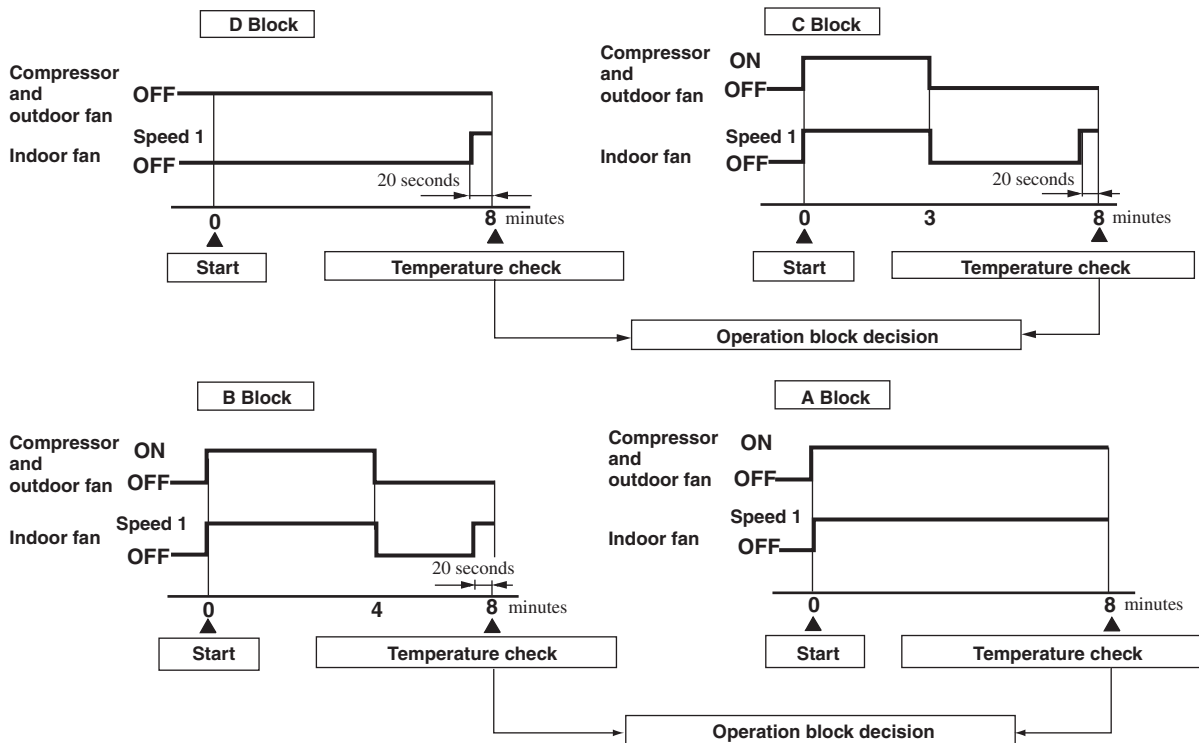

- (4) ECONO operation ( "ECONO" button on the remote controller : ON)

The set temperature changes as shown at right, and the indoor unit fan speed is set on speed 2 .

Running time	Set temperature compensation
Running start ~ 1 hour	Set temperature +0.5
1~2 hours	Set temperature +1.0
2 hours ~	Set temperature +1.5



## 4.9 Automatic operation

### (1) Determination of operation mode

The blow operation of the indoor fan is carried out at the 1st speed for 20 seconds and the room temperature is checked to determine the operation mode automatically. (When the unit is operated by the turn-on timer, the blow operation is not carried out.)

Room temperature	Room temp.<21°C	21°C≤Room temp.<26°C	26°C≤Room temp.
Operation mode	Heating	Dry	Cooling

- (2) Within 30 minutes after either auto or manual operation stops, if auto operation is started, or if you switch to auto operation during manual operation, the system runs in the previous operation mode.
- (3) The temperature is checked 1 time in 30 minutes after the start of operation, and if the judgment differs from the previous operation mode, the operation mode changes.
- (4) Setting temperature can be adjusted within the following range. There is the relationship as shown below between the signals of the wireless remote controller and the setting temperature.

		Signals of wireless remote controller (Display)												
		-6	-5	-4	-3	-2	-1	±0	+1	+2	+3	+4	+5	+6
Setting temperature	Cooling	19	20	21	22	23	24	25	26	27	28	29	30	31
	Dehumidifying	19	20	21	22	23	24	25	26	27	28	29	30	31
	Heating	20	21	22	23	24	25	26	27	28	29	30	31	32

## 4.10 Protective control function

### (1) Frost prevention for indoor heat exchanger (During cooling or dehumidifying)

#### (a) Operating conditions

- (i) Indoor heat exchanger temperature (detected with Th2) is lower than 2.5°C.
- (ii) 3 minutes elapsed after the start of operation.

#### (b) Detail of anti-frost operation

Compressor	OFF
Indoor fan	1st speed
Outdoor fan	OFF
4-way valve	Stop mode

- (c) **Reset condition:** Indoor heat exchanger temperature (Th2) is higher than 8°C.

### (2) Indoor fan motor protection

When the air conditioner is operating and the indoor fan motor is turned ON, if the indoor fan motor has operated at 300 rpm or under for more than 30 seconds, the unit enters first in the stop mode and then stops the entire system.

TIMER light illuminates simultaneously and the operation lamp flashing 6 times at each 8-second.

### (3) Dew condensation prevention control for cooling operation

This prevents dew condensation, in the indoor unit, from occurring.

- (a) **Operating condition:** when compressor is kept ON for 30 min. after the unit starts operation.
- (b) **Operation content:** forces the indoor fan to change from Speed 1 to Speed 2.
- (c) **Resetting condition:** When compressor is off, or when dew condensation prevention control has been operating continuously for 30 minutes.

### (4) Three-minute forced operation

When the compressor begins operating the thermal operation is not effective for 3 minutes, so operation continues as is in the operation mode. (After 3 minutes has passed the thermal operation is effective.)

However, stopping the compressor via a stop signal or protection control has priority.

## (5) High-pressure control

The indoor heat exchanger sensor detection temperature controls the outdoor fan and compressor.

- **When the indoor heat exchanger temperature is  $\geq 58^{\circ}\text{C}$**

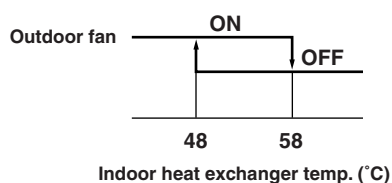

- **When the indoor heat exchanger temperature is  $\geq 62^{\circ}\text{C}$**

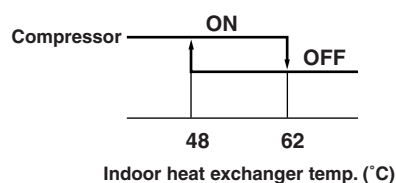

## (6) Current Cut

If current that is higher than the set current flows for 0.5 second continuously, the current to the compressor is cut off. After a 3-minute delay, if the current is 1.5 ~ 2 A or less, the compressor restarts, but if the overcurrent is detected 5 times within 60 minutes after it is detected the first time, it results in an abnormal stop. Also, if the overcurrent continues for 60 minutes, it results in an abnormal stop.

## (7) Compressor overheat protection

If the discharge pipe temperature (sensed by Th6) exceeds the set temperature value, the compressor stops. If the temperature is  $95^{\circ}\text{C}$  or lower after a 3-minute delay, it starts again, but if this function is reactivated again within 60 minutes, it results in an abnormal stop.

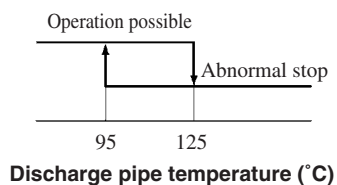

## (8) Serial signal transmission error protection

(a) **Purpose:** Prevents malfunction resulting from error on the indoor  $\leftrightarrow$  outdoor signals.

(b) **Detail of operation:** When the indoor unit controller  $\leftrightarrow$  outdoor unit controller signals cannot be received, the compressor is stopped immediately. Simultaneously, the red LED on the printed circuit board of outdoor unit controller flashing 6 times for 0.5 second at intervals of 8 seconds. Once the operation stops, it does not start any more. (TIMER light on the indoor unit flashing at the same time.)

## (9) Sensor disconnection (room temperature, indoor heat exchanger, outdoor heat exchanger, outdoor air temperature, discharge pipe)

### (a) Room temperature sensor

If the temperature detected by the room temperature sensor is  $-20^{\circ}\text{C}$  or lower continuously for 15 seconds or longer while operation is stopped, an error indication is displayed.

### (b) Indoor heat exchanger sensor

If the temperature detected by the indoor heat exchanger sensor is  $-20^{\circ}\text{C}$  or lower continuously for 15 seconds or longer while operation is stopped, an error indication is displayed.

Also, if the temperature detected by the indoor heat exchanger sensor is  $-20^{\circ}\text{C}$  or lower continuously for 3 minutes after heating operation has started, the indoor unit's fan speed is forcibly raised to speed 5. After this, the air conditioner is stopped if the detected temperature remains at  $-20^{\circ}\text{C}$  continuously for 40 minutes.

### (c) Outdoor heat exchanger sensor

If the temperature detected by the outdoor heat exchanger sensor is  $-50^{\circ}\text{C}$  or lower continuously for 15 seconds or longer while operation is stopped, an error indication is displayed.

Also, the air conditioner is stopped if the temperature detected by the outdoor heat exchanger sensor remains at  $-50^{\circ}\text{C}$  or lower continuously for 40 minutes after heating operation has started.

### (d) Outdoor air temperature sensor





If the temperature detected by the outdoor air temperature sensor is  $-40^{\circ}\text{C}$  or lower continuously for 15 seconds or longer while operation is stopped, an error indication is displayed.

### (e) Discharge pipe sensor

After the compressor has operated for 9 minutes continuously, if there is a disconnected signal for the discharge pipe sensor detected temperature for 15 seconds (less than  $7^{\circ}\text{C}$ ), the compressor stops. After a 3-minute delay, it restarts, but if an abnormality is detected 4 times continuously, the air conditioner is stopped fully and an error indication is displayed.

## 5 APPLICATION DATA



### SAFETY PRECAUTIONS

- Please read these “Safety Precautions” first then accurately execute the installation work.
- Though the precautionary points indicated herein are divided under two headings,  and , those points which are related to the strong possibility of an installation done in error resulting in death or serious injury are listed in the  section. However, there is also a possibility of serious consequences in relationship to the points listed in the  section as well. In either case, important safety related information is indicated, so by all means, properly observe all that is mentioned.
- After completing the installation, along with confirming that no abnormalities were seen from the operation tests, please explain operating methods as well as maintenance methods to the user (customer) of this equipment, based on the owner’s manual. Moreover, ask the customer to keep this sheet together with the owner’s manual.

#### WARNING

- To disconnect the appliance from the mains supply this appliance must be connected to the mains by means of a circuit breaker or a switch (use a recognized 16A) with a contact separation of at least 3mm.
- The appliance shall be installed in accordance with national wiring regulations.
- This system should be applied to places as households, residences and the like. Application to inferior environment such as engineering shop could cause equipment malfunction.
- Please entrust installation to either the company which sold you the equipment or to a professional contractor. Defects from improper installations can be the cause of water leakage, electric shocks and fires.
- Execute the installation accurately, based on following the installation manual. Again, improper installations can result in water leakage, electric shocks and fires.
- For installation, confirm that the installation site can sufficiently support heavy weight. When strength is insufficient, injury can result from a falling of the unit.
- For electrical work, please see that a licensed electrician executes the work while following the safety standards related to electrical equipment, and local regulations as well as the installation instructions, and that only exclusive use circuits are used.  
Insufficient power source circuit capacity and defective installment execution can be the cause of electric shocks and fires.
- Accurately connect wiring using the proper cable, and insure that the external force of the cable is not conducted to the terminal connection part, through properly securing it improper connection or securing can result in heat generation or fire.
- Take care that wiring does not rise upward, and accurately install the lid/service panel. It's improper installation can also result heat generation or fire.
- When setting up or moving the location of the air conditioner, do not mix air etc. or anything other than the designated refrigerant (R22) within the refrigeration cycle.  
Rupture and injury caused by abnormal high pressure can result from such mixing.
- Always use accessory parts and authorized parts for installation construction. Using parts not authorized by this company can result in water leakage, electric shock, fire and refrigerant leakage.
- Ventilate the work area when refrigerant leaks during the operation.   
Coming in contact with fire, refrigerant could generate toxic gas.
- Confirm after the foundation construction work that refrigerant does not leak.  
If coming in contact with fire of a fan heater, a stove or movable cooking stove, etc., refrigerant leaking in the room could generate toxic gas.

#### CAUTION

- Execute proper grounding. Do not connect the ground wire to a gas pipe, water pipe, lightning rod or a telephone ground wire.   
Improper placement of ground wires can result in electric shock.
- The installation of an earth leakage breaker is necessary depending on the established location of the unit.  
No installing an earth leakage breaker may result in electric shock.
- Do not install the unit where there is a concern about leakage of combustible gas.   
The rare even of leaked gas collecting around the unit could result in an outbreak of fire.
- For the drain pipe, follow the installation manual to insure that it allows proper drainage and thermally insulate it to prevent condensation. Inadequate plumbing can result in water leakage and water damage to interior items.

## 5.1 Selection of location for installation

### (1) Indoor unit

- Where there is no obstructions to the air flow and where the cooled air can be evenly distributed.
- A solid place where the unit or the wall will not vibrate.
- A place where there will be enough space for servicing. (Where space mentioned below can be secured)
- Where wiring and the piping work will be easy to conduct.
- The place where receiving part is not exposed to the direct rays of the sun or the strong rays of the street lighting.

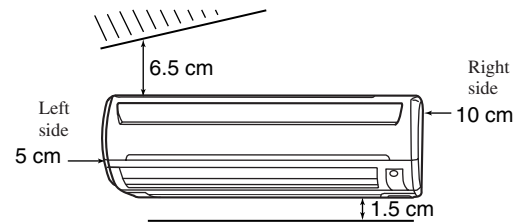

### (2) Outdoor unit

- A place where good air circulation can be obtained and where rain, snow or sunshine will not directly strike the unit.
- A place where discharged hot air or unit's operating sound will not be a nuisance to the neighborhood.
- A place where servicing space can be secured.
- A place where vibration will not be enlarged.

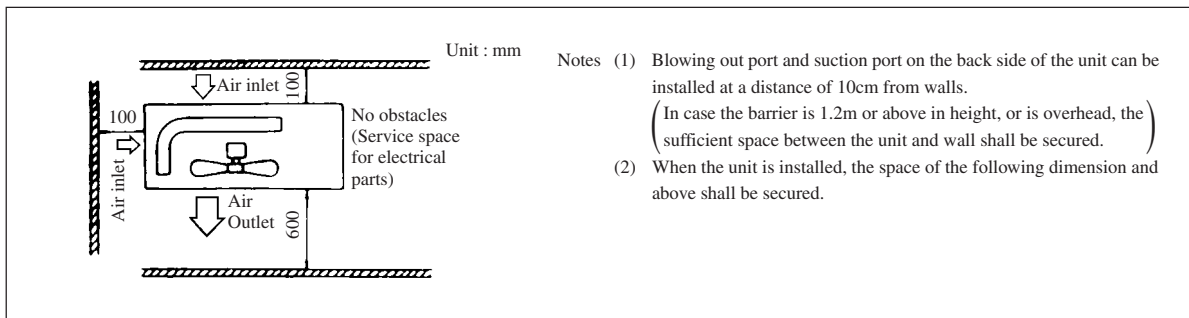

- In heating operation, snow deposit on the heat-exchanger of outdoor unit must be prevented for keeping the normal performance capacity.
  - Snow-hood on outdoor unit as in drawing, will reduce the frequency of defrost operation.  
When installing the snow hood, take care so that the air outlet of the snow hood will not face directly into the most windy direction.
  - Design the base higher than possible snow deposit.

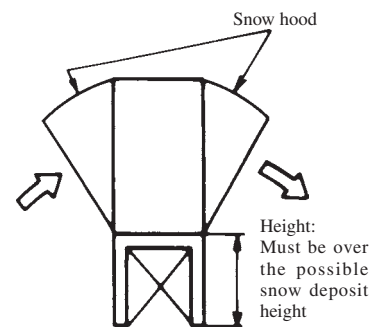

### (3) Limitations for one way piping length and vertical height difference.

Item	Model	SRK20HD
One way piping length ( $l$ )		15 m
Vertical height difference ( $h$ )	Outdoor unit is lower	5 m
	Outdoor unit is higher	5 m

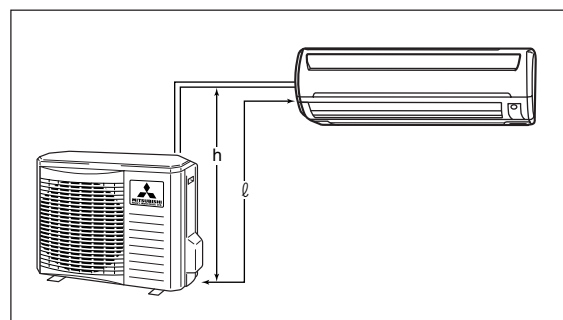

## 5.2 Installation of indoor unit

### (1) Installation of installation board

#### (a) Fixing of installation board

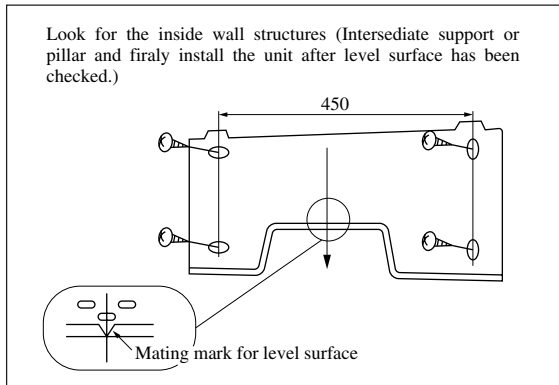

Adjustment of the installation board in the horizontal direction is to be conducted with four screws in a temporary tightened state.

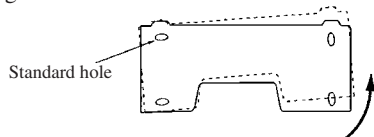

Adjust so that board will be level by turning the board with the standard hole as the center.

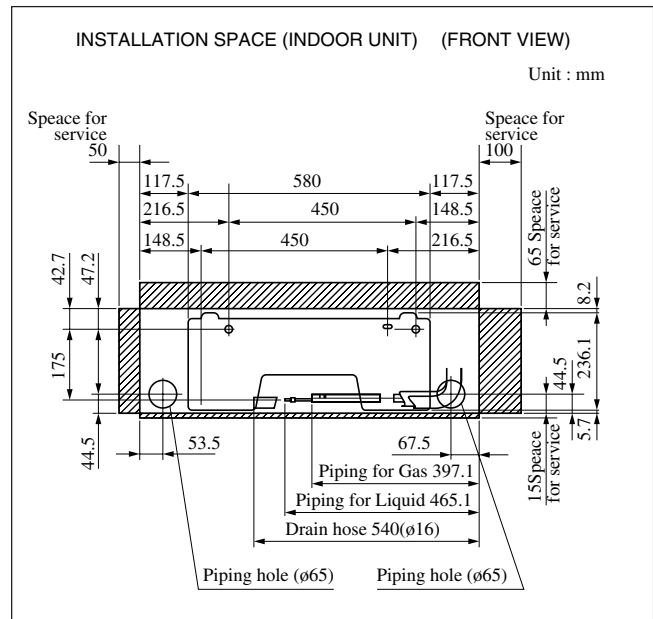

### (2) Drilling of holes and fixture sleeve (Option parts)

When drilling the wall that contains a metal lath, wire lath or metal plate, be sure to use pipe hole sleeve sold separately.

#### (a) Drill a hole with ø65

##### whole core drill

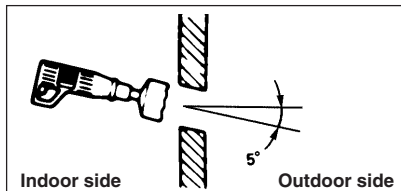

Note (1) Drill a hole with incline of 5 degree from indoor side to outdoor side.

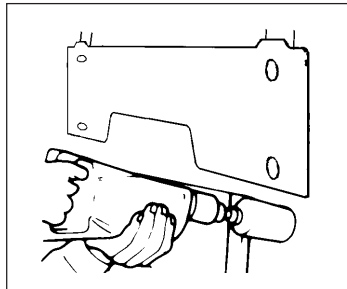

#### (b) Adjusting sleeve length

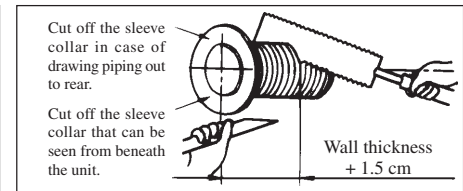

#### (c) Install the sleeve

(Inserting sleeve)

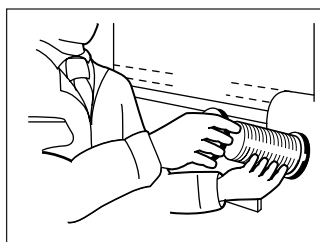

(\*Sleeve + \*Inclined + \*Sealing plate)

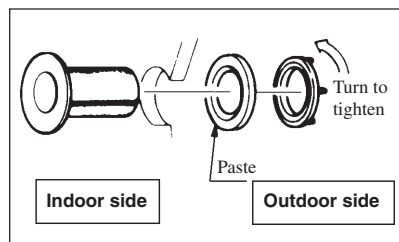

View of sleeve when installed

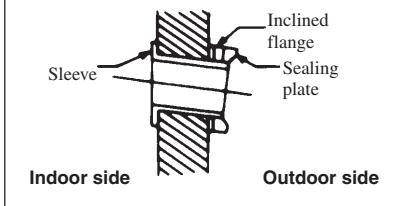

### (3) Preparation of indoor unit

#### (a) Mounting of connecting wires

- 1) Remove the lid (R).
- 2) Remove the terminal cover.
- 3) Remove the wiring clamp.
- 4) Connect the connecting wire securely to the terminal block.

Use cables for interconnection wiring to avoid loosening of the wires.

CENELEC code for cables. Required field cables.

H05 RNR3G1.5 (Example) or 245IEC57

H Harmonized cable type

05 300/500 volts

R Natural-and/or synth, rubber wire insulation

N Polychloroprene rubber conductors insulation

R Standed core

4or5 Number of conductors

G One conductor of the cable is the earth conductor (yellow/green)

1.5 Section of copper wire (mm<sup>2</sup>)

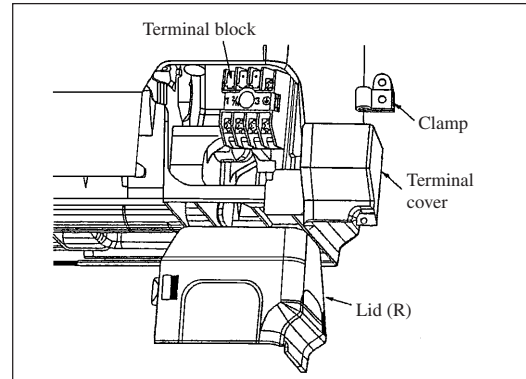

- ① Connect the connection wire securely to the terminal block. If the wire is not affixed completely, contact will be poor, and it is dangerous as the terminal block may heat up and catch fire.
  - ② Take care not to confuse the terminal numbers for indoor and outdoor connections.
  - ③ Affix the connection wire using the wiring clamp.
- 5) Fix the connecting wire by wiring clamp.
  - 6) Attach the lid.
  - 7) Close the air inlet panel.

**(b) Protective taping** (Protect the cable with tape at the section where the cable passes through the hole opened on the wall.)

**(c) Forming of pipe** (Holding down the pipe at the root, change the pipe direction, extend it and adjust according to the circumstance.)

**[When the pipe is extended to left and taken out from the rear center]**

(Drain pipe relocation procedure)

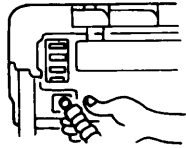
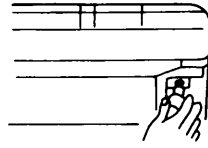
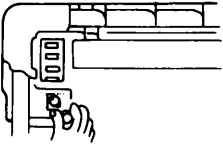
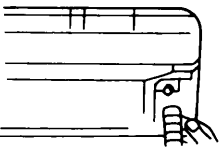
1. Remove the drain pipe.	2. Remove the drain cap.	3. Insert the drain cap.	4. Connect the drain pipe.
			

• Loosen the spring clamp to remove.

• Remove by hand or use cutting pliers, etc.

• Securely insert the drain cap removed in the step 2.  
Note: If it is inserted insufficiently, water leakage could result.

• Loosen the spring clamp and securely insert the drain pipe.  
Note: If it is inserted insufficiently, water leakage could result.

Since this air conditioner has been designed to collect dew drops on the rear surface to the drain pan, do not attach the power cord above the gutter.

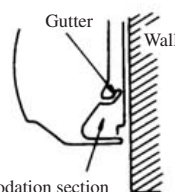

Pipe accommodation section

#### (4) Installation of indoor unit

##### (a) Install the indoor unit on the mounting plate.

Hook the upper part of the indoor unit on the stoppers disposed at the upper part of the mounting plate and lightly push the lower part of the indoor unit so that the unit is fixed in position.

- When removing the indoor unit
  - 1) Disconnect the lid at right and left.
  - 2) Pull down the stoppers (right and left) provided at the bottom of the indoor unit base. (See the detail view shown at right.)

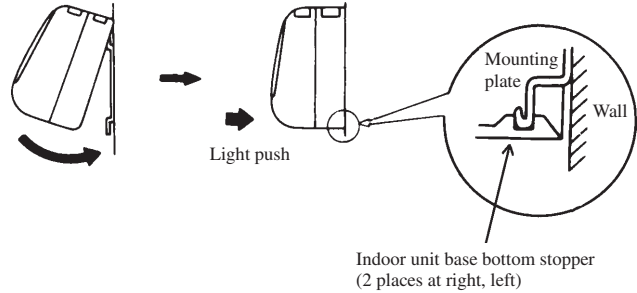

##### (b) Be sure not to leave any trap on the drain pipe.

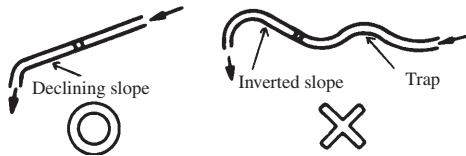

### 5.3 Installation of outdoor unit

#### (1) Installation of outdoor unit

- Make sure that sufficient space for installation and service is secured.
- Fix the leg sections of the unit on a firm base which will not play. Attach cushion pads, etc. between the unit and the mounting fixtures not to transmit vibration to the building.
- Attach a drain elbow, etc. under the drain port of the bottom plate to guide drain water. (Drain elbow should not be used where days when temperature drops below 0°C continue for several days. Draining may be disturbed by frozen water.)
- When installing the unit at a higher place or where it could be toppled with strong winds, secure the unit firmly with foundation bolts, wire, etc.

#### (2) Connection of indoor and outdoor connecting wiring

- Connect the wiring according to the number of the indoor terminal block. (Mis-wiring may cause the burning damage, and make sure to connect correctly.)

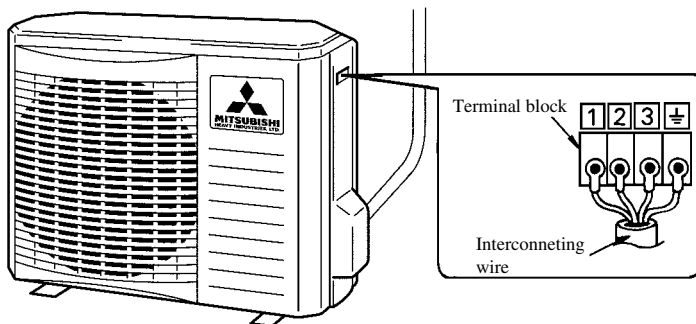

1	<b>Brown</b>	For power supply, indoor outdoor
2	<b>Blue</b>	Connecting wiring
3	<b>Black</b>	Indoor/outdoor signal wire (Low voltage)
⊕	<b>Yellow/Green</b>	Earth wiring terminal

Notes (1) To prevent the mis-operation by noise, when the connecting wire too long for indoor and outdoor. Please hide the fixed wire in the pipe or use vinyl tape to set. Do not put wire into the unit.

(2) Please let the anchored personal to decide by indoor wiring code whether connect the leakage breaker or not.

### 5.4 Refrigerant piping

#### (1) Preparation

Keep the openings of the pipes covered with tapes etc. to prevent dust, sand, etc. from entering them.

Indoor unit side	Outdoor unit side	
<ul style="list-style-type: none"> <li>• Remove the flared nuts. (on both liquid and gas sides)</li> </ul>	<ul style="list-style-type: none"> <li>• Remove the flared nuts. (on both liquid and gas sides)</li> </ul>	
		Dimension A Liquid side (φ6.35): 9.0 dia Gas side (φ9.52): 13.0 dia



## (2) Connection of refrigerant piping

### Indoor unit side

- Connect firmly gas and liquid side pipings by Torque wrench.

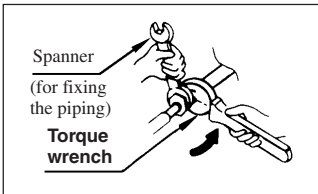

- Specified torquing value:  
**Liquid side (ø6.35) : 14.0~18.0 N·m(1.4~1.8 kgf·m)**  
**Gas side (ø9.52) : 34.0~42.0 N·m(3.4~4.2 kgf·m)**

### Outdoor unit side

- Connect firmly gas and liquid side pipings by Torque wrench.

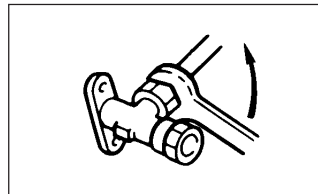

- Specified torquing value:  
**Liquid side (ø6.35) : 14.0~18.0 N·m(1.4~1.8 kgf·m)**  
**Gas side (ø9.52) : 34.0~42.0 N·m(3.4~4.2 kgf·m)**

- Use one more spanner to fix the valve.
- Always use a Torque wrench and back up spanner to tighten the flare nut.

## (3) Air purge

- Tighten all flare nuts in the pipings both indoor and outside will so as not to cause leak.
- Connect service valve, charge hose, manifold valve and vacuum pump as is illustrated below.
- Open manifold valve handle Lo to its full width, and perform vacuum or evacuation.  
Continue the vacuum or evacuation operation for 15 minutes or more and check to see that the vacuum gauge reads  $-0.1\text{MPa}$  ( $-76\text{cm Hg}$ ).
- After completing vacuum operation, fully open service valve (Both gas and liquid sides) with hexagon headed wrench.
- Check for possible leakage of gas in the connection parts of both indoor and outdoor.

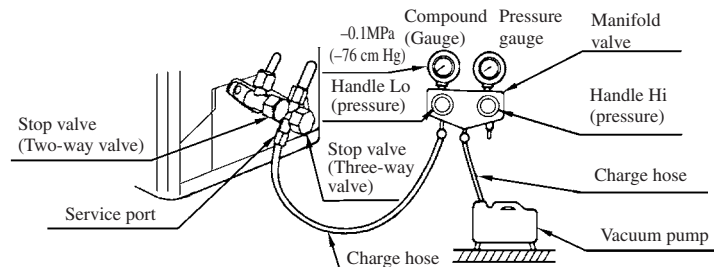

### Additional refrigerant charge

When refrigerant piping exceeds 7.5m conduct additional refrigerant charge after refrigerant sweeping.

Max. 10m	Additional charge amount per meter = 20g/m
10m over 15m	Additional charge amount per meter = 30g/m

[Example]

How much amount of additional charge for 10m piping?

$$(10 - 7.5)\text{m} \times 20\text{g/m} = 50\text{g} \quad \boxed{50\text{g for additional charge}}$$

How much amount of additional charge for 15m piping?

$$(10 - 7.5)\text{m} \times 20\text{g/m} + (15 - 10)\text{m} \times 30\text{g/m} = 200\text{g} \quad \boxed{200\text{g for additional charge}}$$

## (4) Insulation of connecting portion

- Cover the connection portion of the refrigerant piping with the pipe cover and seal them.  
If neglecting to do so, moisture occurs on the piping and water will drip out.

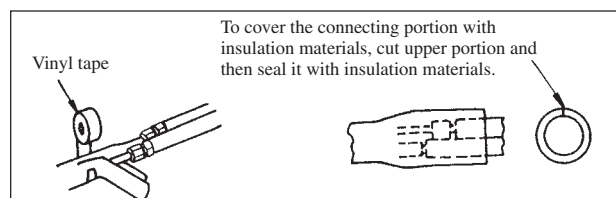



- 2) Finishing and fixing
  - a) Tie up the piping with wrapping tape, and shape it so that it conforms to which the pipe is attached.
  - b) Fix them with clamps as right figure.

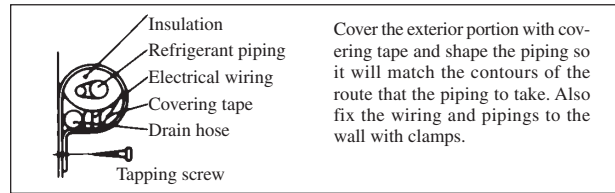

Cover the exterior portion with covering tape and shape the piping so it will match the contours of the route that the piping to take. Also fix the wiring and pipings to the wall with clamps.

## 5.5 Test run

- (1) Conduct trial run after confirming that there is no gas leaks.
- (2) When conducting trial run set the remote controller thermostat to continuous operation position. However when the power source is cut off or when the unit's operation switch is turned off or was turned to fan operation position, the unit will not go into operation in order to protect the compressor.
- (3) Insert in electric plug into the electric outlet and make sure that it is not loose.
  - (a) When there is something wrong with the electric outlet and if the insertion of the electric plug is insufficient, there may occur a burn out.
  - (b) It is very important to be careful of above when plugging in the unit to an already furnished electrical outlet.
- (4) Explain to the customer on the correct usage of the air conditioner in simple layman's terms.
- (5) Make sure that drain flows properly.

### (6) Standard operation data

(220/230/240V)

Item	Model	SRK20HD
High pressure MPa(kgf/cm <sup>2</sup> )	Cooling	—
	Heating	1.48~1.64 (15~17)
Low pressure MPa(kgf/cm <sup>2</sup> )	Cooling	0.57~0.69 (6~7)
	Heating	—
Temp. difference between return air and supply air (°C)	Cooling	12~14
	Heating	14~16
Running current (A)	Cooling	3.1/3.0/2.9
	Heating	3.0/2.9/2.8

Note (1) The data are measured at following conditions.  
 Ambient air temperature  
 Indoor side: Cooling ... 27°C DB, 19°C WB, Heating ... 20°C DB  
 Outdoor side: Cooling ... 35°C DB, 24°C WB, Heating ... 7°C DB, 6°C WB

## 5.6 Precautions for wireless remote controller installation and operation

### (1) Wireless remote controller covers the following distances:

#### (a) When operating facing the air conditioner:

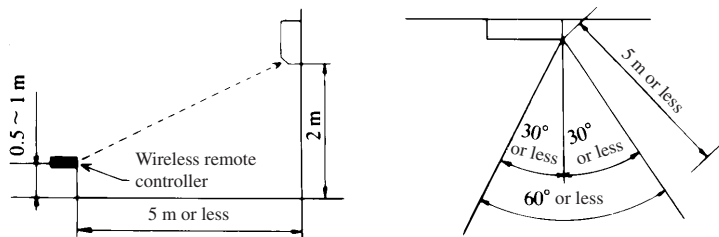

- Notes (1) The remote controller is correctly facing the sensing element of the air conditioner when being manipulated.
- (2) The typical coverage is indicated (in the left illustration). It may be more or less depending on the installation.
- (3) The coverage may be less or even nil. If the sensing element is exposed to strong light, such as direct sunlight, illumination, etc., or dust is deposited on it or it is used behind a curtain, etc.

#### (b) When manipulating the remote controller mounted on a wall:

Make sure that it works normally (i.e., transmission/reception signal is audible) before mounting.

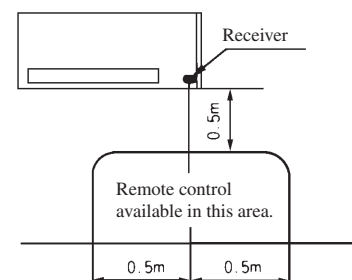

# 6 MAINTENANCE DATA

## 6.1 Trouble shooting

### (1) Trouble shooting to be performed prior to exchanging PCB, (Printed circuit board) [Common to all models]

All the models described in this chapter are controlled by a microcomputer. When providing maintenance service to customers it is necessary to understand the function controlled by a micro computer thoroughly, so as not to mistakenly identify correct operations as mis-operations. It is also necessary to perform the following simple checks before conducting detailed checks or exchanging printed circuit board.

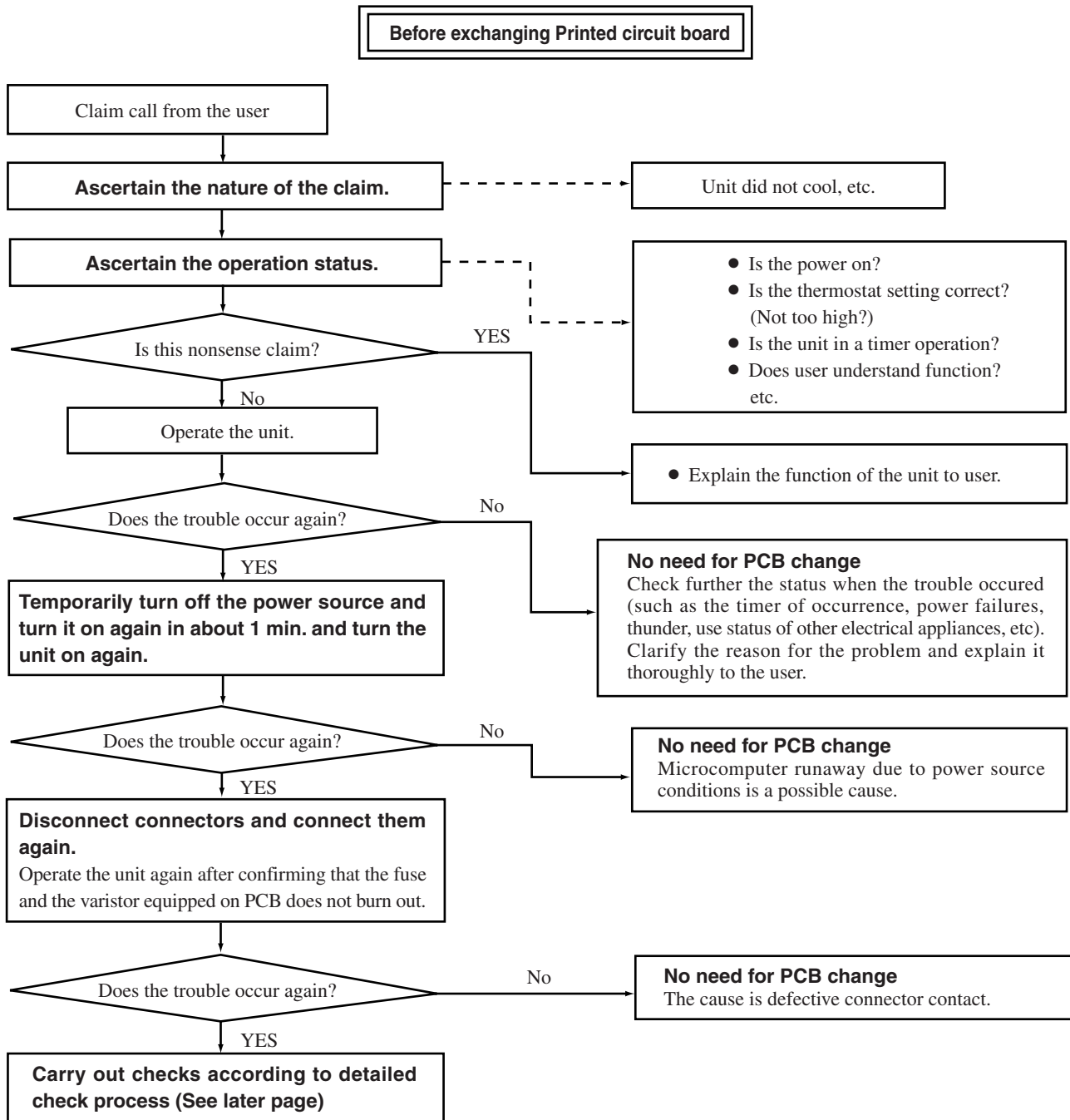

(2) Self diagnosis display on indoor unit

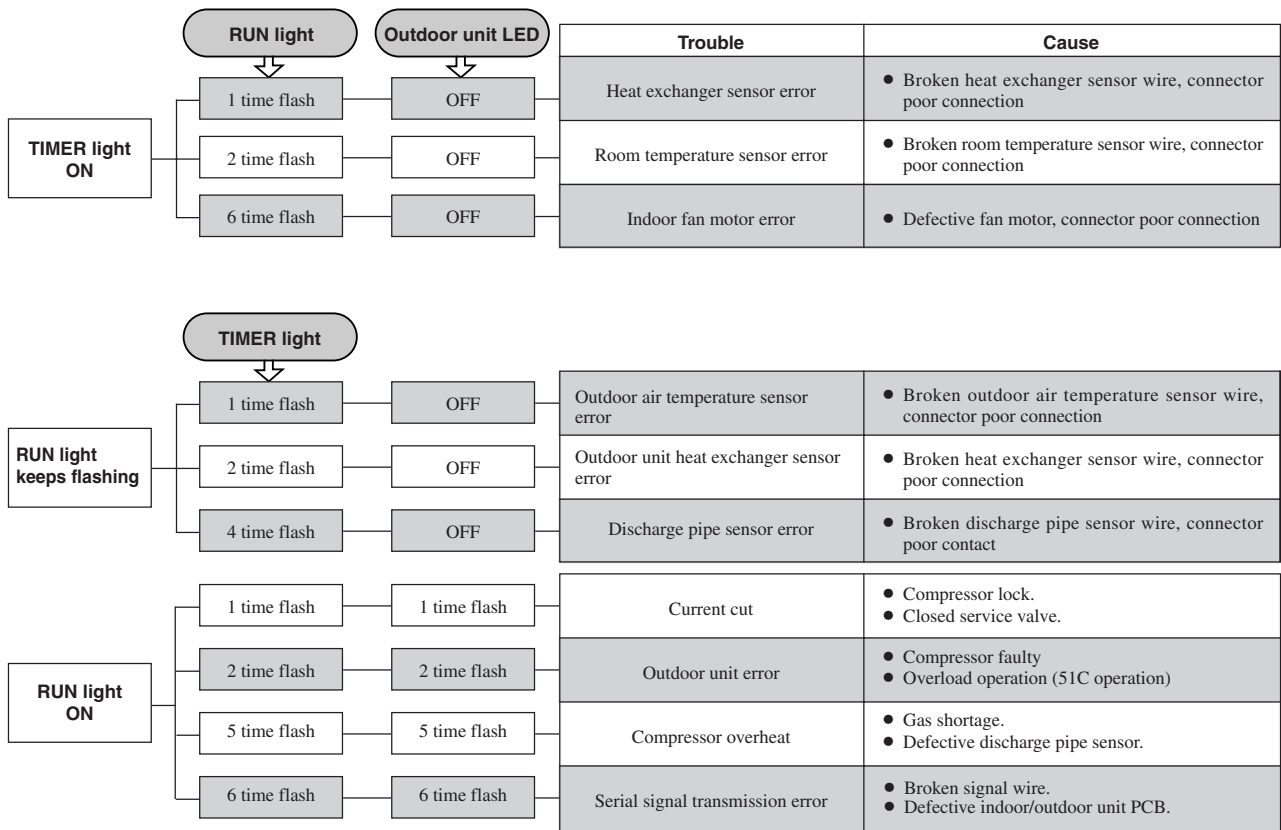

(3) Inspection procedures corresponding to detail of trouble

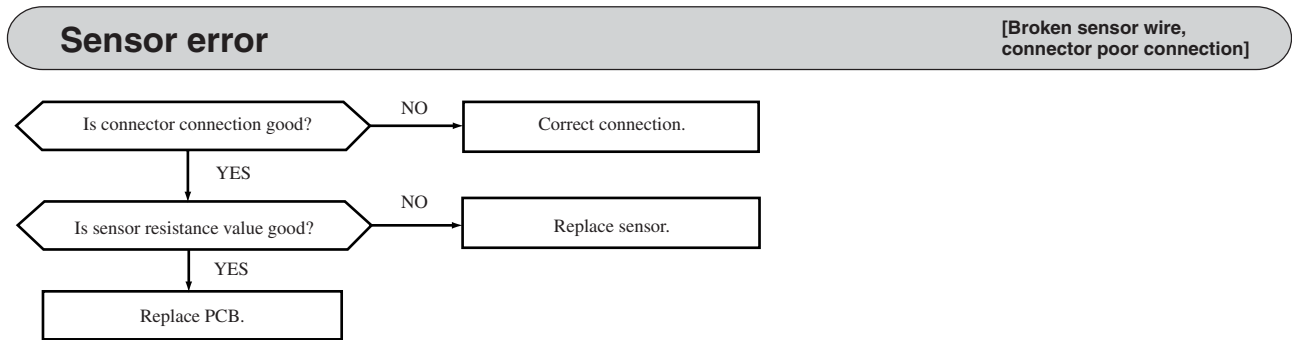

◆ Discharge pipe sensor temperature characteristics

Temperature (°C)	Resistance (kΩ)	Temperature (°C)	Resistance (kΩ)
0	164	70	8.7
5	127	75	7.3
10	99	80	6.2
15	78	85	5.3
20	62	90	4.5
25	50	95	3.9
30	40	100	3.3
35	32	105	2.9
40	26	110	2.5
45	21	115	2.2
50	17	120	1.9
55	14	125	1.6
60	12	130	1.4
65	10	135	1.3

◆ Sensor temperature characteristics (Room temp., indoor unit heat exchanger temp., outdoor unit heat exchanger temp., outdoor air temp.)

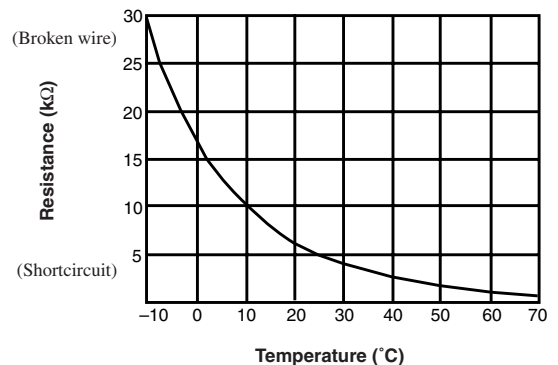

## Current cut

[compressor lock]

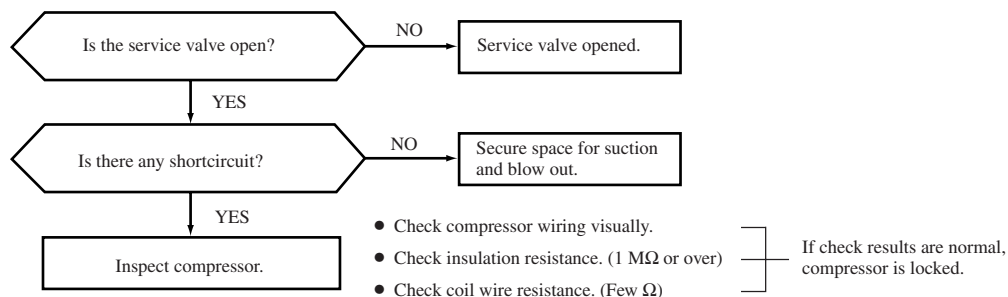

## Outdoor unit abnormal

[Compressor faulty, compressor wiring disconnected.]

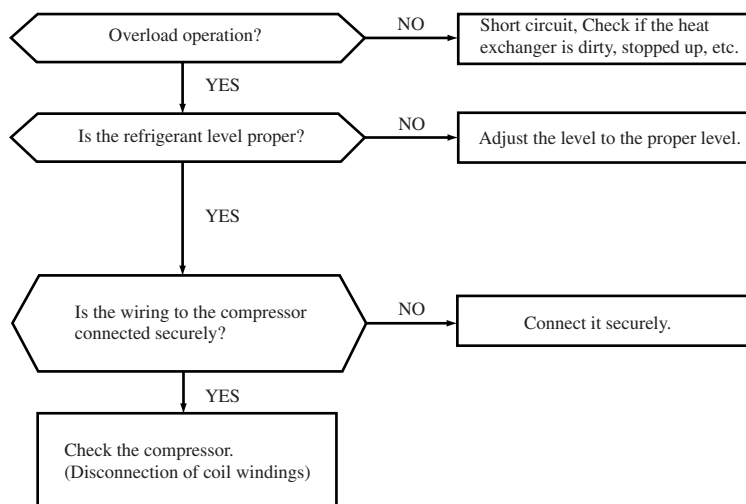

## Compressor overheat

[Gas shortage, defective discharge pipe sensor]

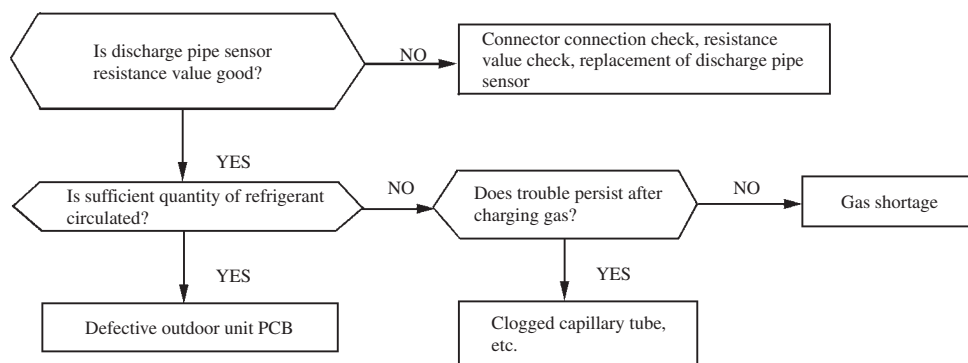

## Indoor fan motor error

[Defective fan motor, defective PCB]

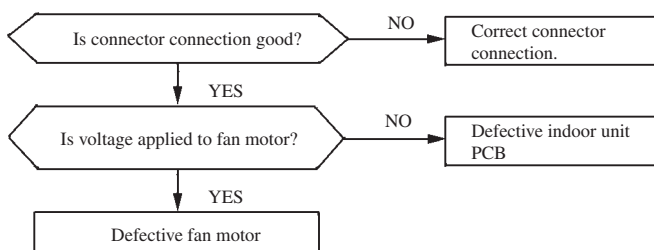

## Serial signal transmission error

[Wiring error including power cable, defective indoor/  
outdoor unit PCB]

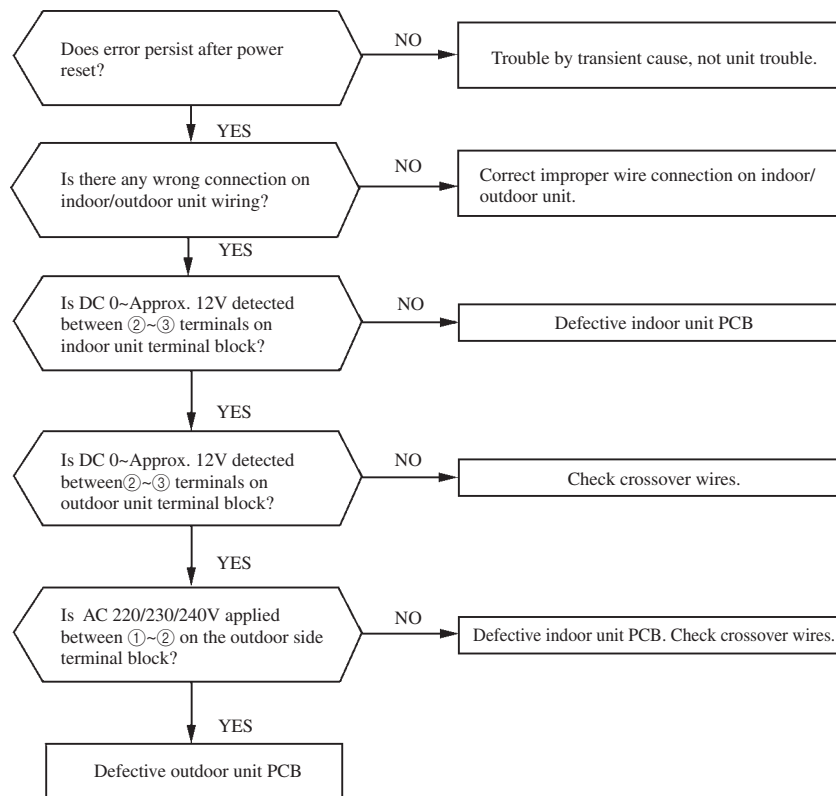

#### (4) Phenomenon observed after shortcircuit, wire breakage on sensor.

##### (a) Indoor unit

Sensor	Operation mode	Phenomenon	
		Shortcircuit	Broken wire
Room temperature sensor	Cooling	Release of continuous compressor operation command	Continuous compressor operation command is not released.
	Heating	Continuous compressor operation command is not released.	Release of continuous compressor operation command
Heat exchanger sensor	Cooling	System can be operated normally.	Continuous compressor operation command is not released. (Anti-frosting)
	Heating	High pressure control mode	Hot keep (Indoor fan stop)

##### (b) Outdoor unit

sensor	Operation mode	Phenomenon	
		Shortcircuit	Broken wire
Heat exchanger sensor	Cooling	System can be operated normally.	System can be operated normally.
	Heating	Defrosting is not performed.	Defrosting is performed for 10 minutes at approx. 1 hour.
Outdoor air temperature sensor	Cooling	System can be operated normally.	System can be operated normally.
	Heating	Defrosting is not operated.	Defrosting is performed for 10 minutes at intervals of approx. 1 hour.
Discharge pipe sensor	All modes	Compressor overload protection is disabled. (Can be operated.)	Compressor stop

### (5) Inspection procedures of indoor electrical equipment

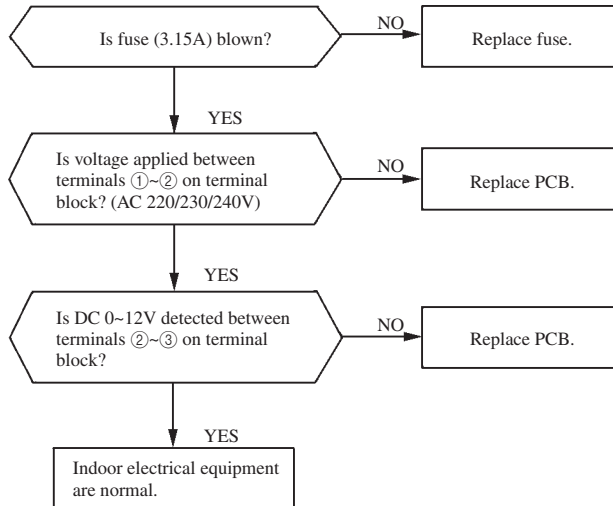

Notes (1) Since the communication timing signal is transmitted only when the 52C is turned ON, check it under the operating condition.

(2) Check the voltage on the terminal block.

- Power supply: Between ①~② (AC 220/230/240V)
- Signal: Between ②~③ (Changing between DC 0~Approx. 12V)

### (6) How to make sure of remote controller

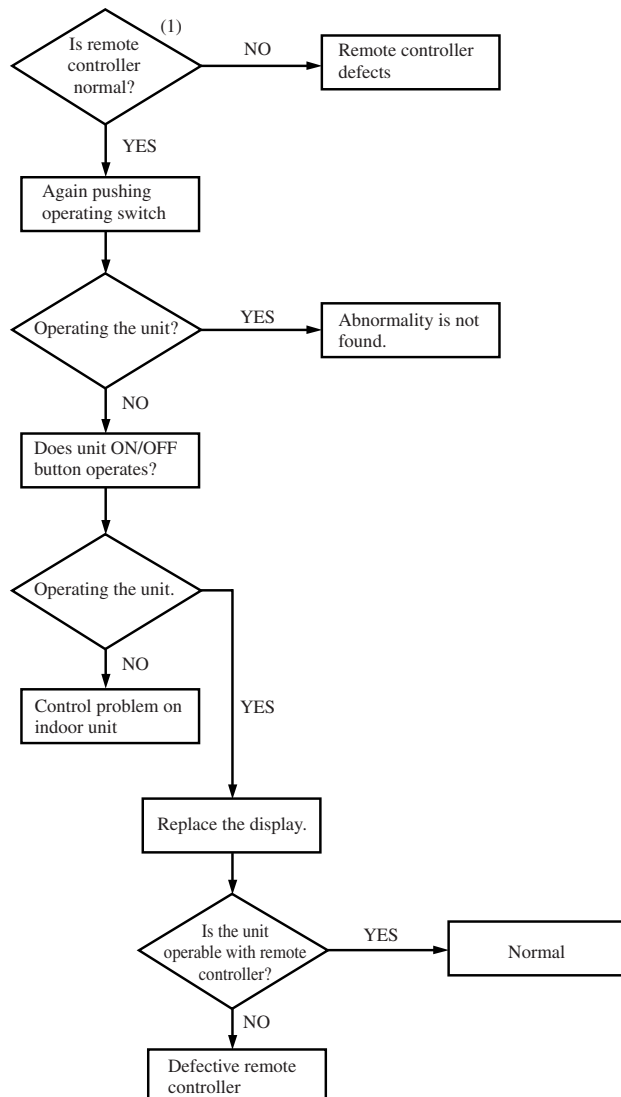

Note (1) Check method of remote controller

- (a) Press the reset switch of the remote controller.
- (b) If all LCD are displayed after zero (0) display, it is basically normal.

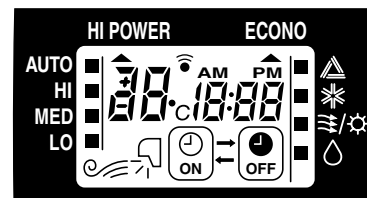

## 6.2 Servicing

### (1) Evacuation

The evacuation is an procedure to purge impurities.....noncondensable gas, air, moisture from the refrigerant equipment by using a vacuum pump. Since the refrigerant R22 is very insoluble in water, even a small amount of moisture left in the refrigerant equipment will freeze, causing what is called water clogging.

- Evacuation procedure

- Check to ensure that there is no internal pressure in the unit. If there is an internal pressure, it should be relieved through the check joint.
- Connect the service hoses of the gauge manifold to the check joint of the gas & liquid piping.
- Connect a vacuum pump to the charge hose (A). Repeat evacuation in the following sequence.

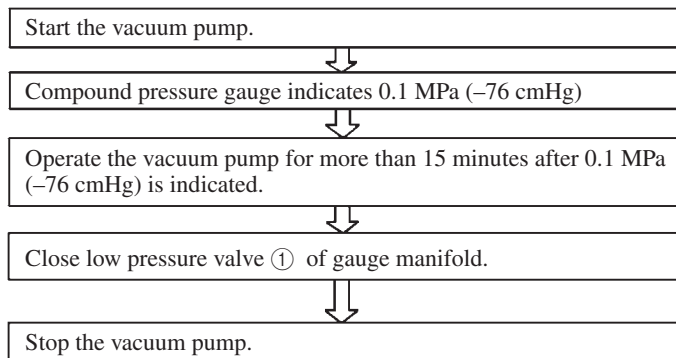

- Notes
- (1) Do not use the refrigerant pressure to expel air.
  - (2) Do not use the compressor for evacuation.
  - (3) Do not operate the compressor in the vacuum condition.

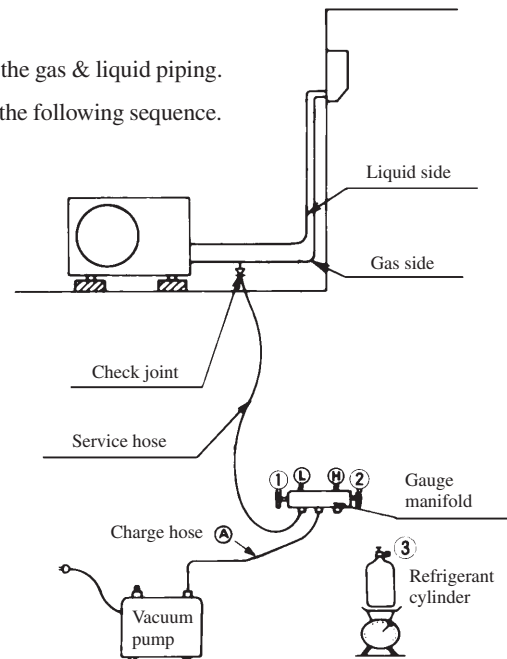

### (2) Refrigerant charge

- Discharge refrigerant entirely from the unit and evacuate the unit.

Note: Addition of refrigerant without evacuation is unreasonable, because it will result in low charge or overcharge.

- Keep the gauge manifold and connect a refrigerant cylinder to the unit.
- Record the weight of the refrigerant cylinder on the balance. This is necessary for making sure of the charged refrigerant amount.
- Purge air from the charge hose (A)  
Firstly loose the connecting portion of the charge hose (A) at the gauge manifold side and open the valve (3) for a few seconds, and then immediately retighten it after observing that gas is blow out from the loosened portion.
- Open the valve (1) and (3) after discharging air from the charge hose (A), then the gas refrigerant begins flowing from the cylinder into the unit. Be sure to erect the refrigerant cylinder upright to let gas refrigerant flow into the unit.
- When refrigerant has been charged into the system to some extent, refrigerant flow becomes stagnant, when that happens, start the compressor in cooling cycle until the unit is filled with gas to the specified weight.
- Making sure of the refrigerant amount, close the valve (3)
- Disconnect the charge hose from the unit. Cover the valve ports of the refrigerant piping with caps and tighten them securely.
- Check for gas leakage applying a gas leak detector along the piping line.
- Start the air conditioner and make sure of its operating condition.....high side and low side pressures and temperature difference between suction air and outlet air.

# MEMO



---

## **WALL MOUNTED TYPE ROOM AIR-CONDITIONER**

---



---

Air-Conditioning & Refrigeration Systems Headquarters  
16-5, 2-chome, Kounan, Minato-ku, Tokyo, 108-8215, Japan  
Fax : (03) 6716-5926



**Большая библиотека технической документации  
<http://splitoff.ru/tehn-doc.html>  
каталоги, инструкции, сервисные мануалы, схемы.**